

TYLÖ[®]
for the senses



TYLÖ PANACEA
TECHNICAL INFORMATION



Introducing the Panacea steam bath

The Panacea steam bath is designed to integrate well into private homes or commercial settings alike. Manifesting itself through carefully appointed materials and a restrained design, Panacea gives a strong, yet exclusive impression. With its custom-made appearance and innovative solutions, the user indulges in a therapeutic sensation, surrounded by opaque glass walls and Corian® benches. With several personal settings available, the user has the option to remotely control temperature, light, aromatherapy, steam and more. Like the rest of the interior, the steam outlet is also made out of glass and Corian®, which, in addition to being extremely quiet, also functions as an aesthetic feature. With its' near seamless construction and choice of materials, the Panacea steam bath is made with easy maintenance and hygiene in mind.

Use the Panacea steam bath configurator

In line with the ingenious and modular construction, we have outlined four easy steps in order for you to easily configure your Panacea steam bath. Follow the steps below and finish by e-mailing the result to order.se@tylohelo.com.

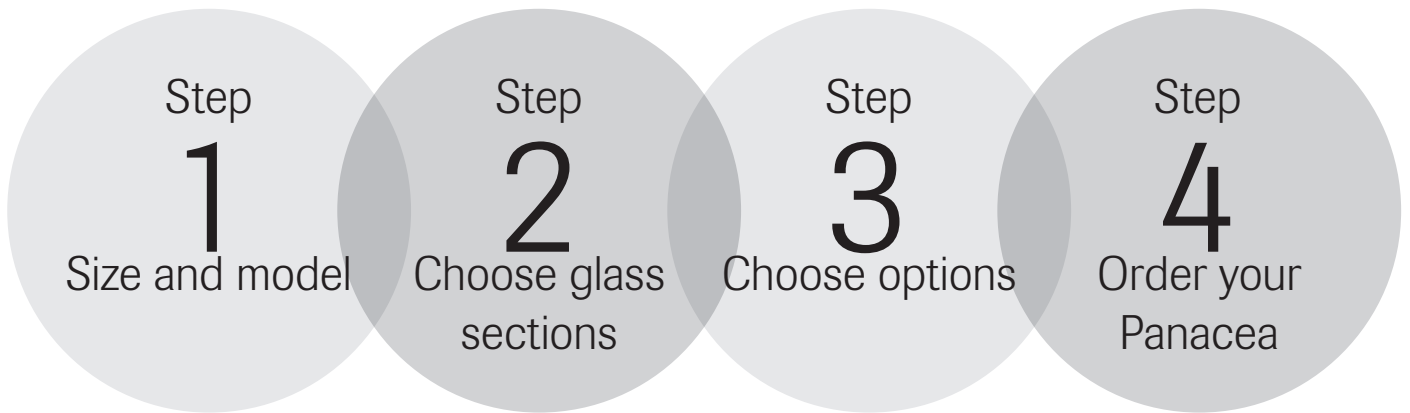

The Panacea steam bath comes in 7 different sizes and 15 different models. Choose the one that best suits your needs and fit the measurements of the available space.

The Panacea steam bath comes equipped with glass wall sections as shown in the layouts on page 4-6. As a no cost option, you have the possibility to replace the standard sections with either smoke colored, tinted or black glass.

The Panacea steam bath comes with a whole host of available options to make the steam bath experience an even more pleasurable one. On page 7 you will find a selection of convenient and desirable optional features.

E-mail the specification for the Panacea steam bath that you have just configured to order.se@tylohelo.com and your order is complete.

Take a look at your options

On the following pages all the different layouts, wall sections and bench configurations are presented.

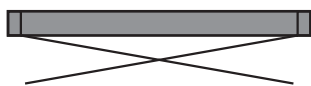

Smoke colored glass door with threshold
Door hung to the right or the left
(800, 1000)

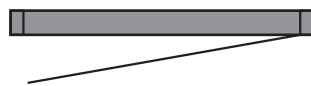

Smoke colored glass with threshold
Door hung to the right*
(800, 1000)



Glass door without threshold
Door hung to the right or the left
(800, 1000)

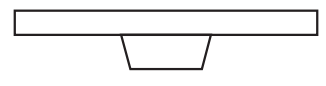

Mood lit back section with steam column
including steam generator and shower
(800)

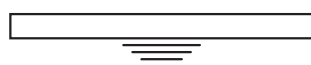

Mood lit back section with
steam outlet
(800)



Transparent smoke colored glass
(300, 400, 600, 800)

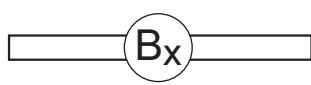

Opaque pale glass/basic (pale tint on
the inside, non transparent)
(400, 800)



Opaque pale glass/black glass (pale
tint on the inside, non transparent)
(400, 800)

* Reversed layout also reverses position of door. Applicable on models 1309 t and 1309 tx/t.

Panacea steam bath – door 800 and Corian® benches

See below for all the standard plans for the Panacea steam bath and the different wall sections available as no cost options.

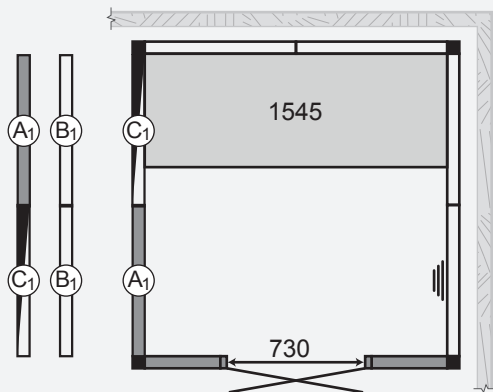

1717 Black 1B
 Item no: 9607 5070
 Meas: 1730mm x 1730mm
 No vent: 6kW/ with vent: 6kW

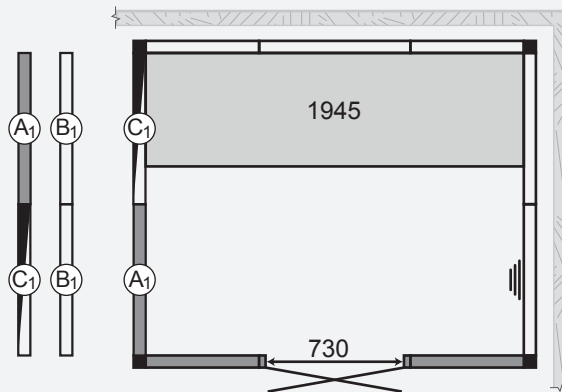

2117 Black 1B
 Item no: 9607 5074
 Meas: 2130mm x 1730mm
 No vent: 6kW/ with vent: 6kW

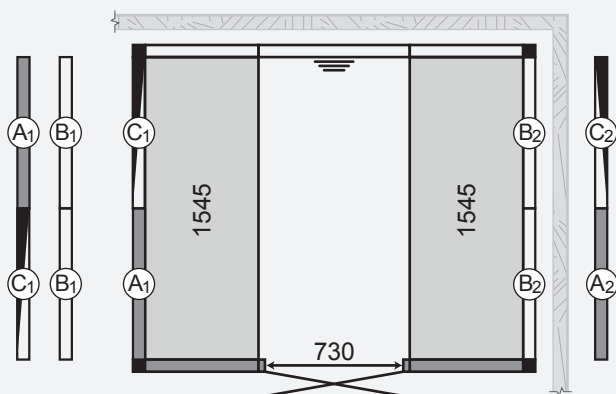

2117 Black 2B
 Item no: 9607 5076
 Meas: 2130mm x 1730mm
 No vent: 6kW/ with vent: 6kW

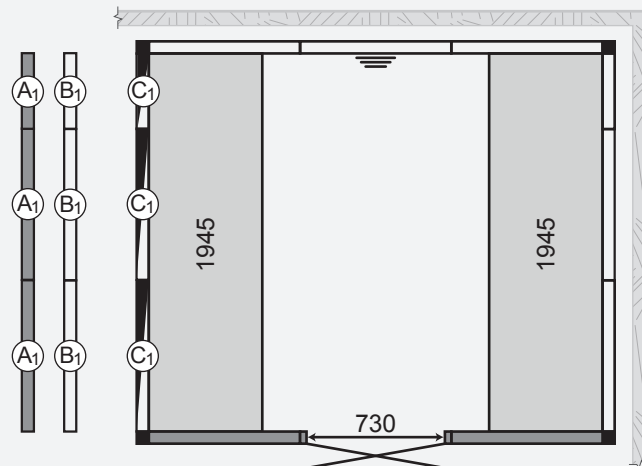

2521 Black 2B
 Item no: 9607 5080
 Meas: 2530mm x 2130mm
 No vent: 6kW/ with vent: 9kW

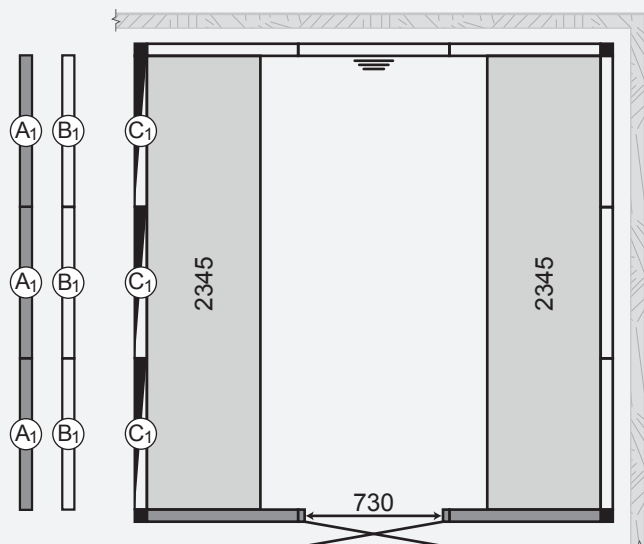

2525 Black 2B
 Item no: 9607 5084
 Meas: 2530mm x 2530mm
 No vent: 9kW/ with vent: 9kW

Panacea steam bath – door 1000 and Corian® benches

To further enhance versatility and accessibility of the Panacea steam bath, we offer a wheel chair access version with a wider door opening. See below for plans and the different wall sections available as no cost options.

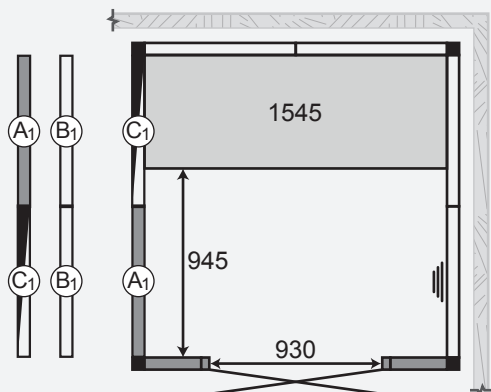

1717 Black 1B WD
Item no: 9607 5072
Meas: 1730mm x 1730mm
No vent: 6kW/ with vent: 6kW

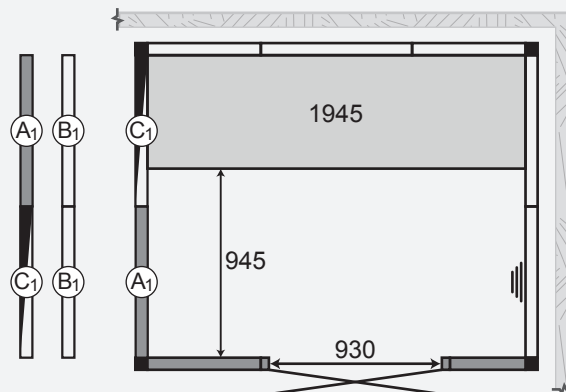



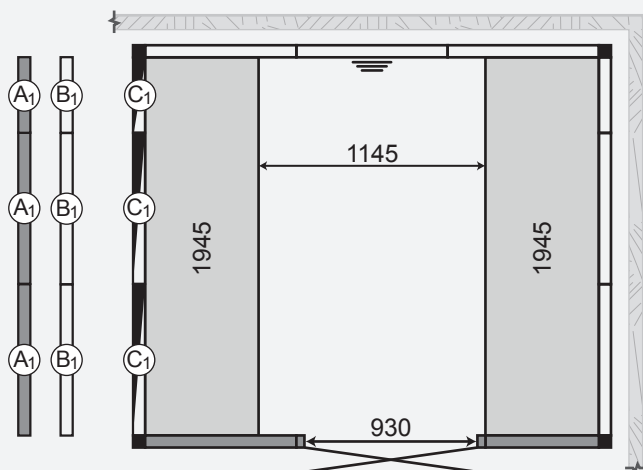

2117 Black 1B WD
Item no: 9607 5078
Meas: 2130mm x 1730mm
No vent: 6kW/ with vent: 6kW

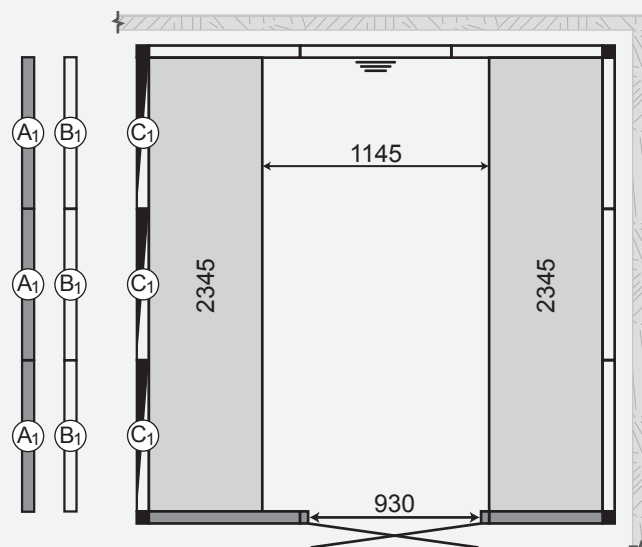

2521 Black 2B WD
Item no: 9607 5082
Meas: 2530mm x 2130mm
No vent: 6kW/ with vent: 9kW



2525 Black 2B WD
Item no: 9607 5086
Meas: 2530mm x 2530mm
No vent: 9kW/ with vent: 9kW

-  Mood lit back section with steam outlet
-  Transparent smoke colored glass
-  Opaque pale glass/basic (pale tint on the inside, non transparent)
-  Opaque pale glass/black glass (pale tint on the inside, non transparent)

Panacea steam bath models 1309 and 1709

See below for all the standard plans for the compact Panacea steam bath 1309 and 1709. Like the larger models they have different wall sections available as no cost options. The portable and adjustable benches are made of Corian®. Also available with shower tray.

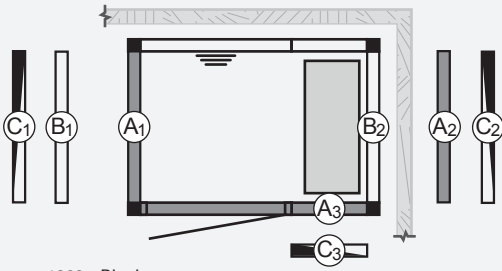

1309 t Black
 Item no: 9607 5020
 Meas: 1330mm x 930mm
 No vent: 2.2kW/ with vent: 4.5kW

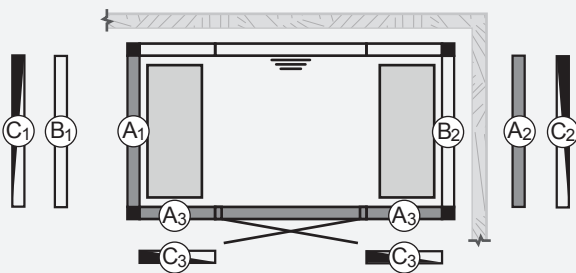

1709 t Black
 Item no: 9607 5022
 Meas: 1730mm x 930mm
 No vent: 4.5kW/ with vent: 4.5kW

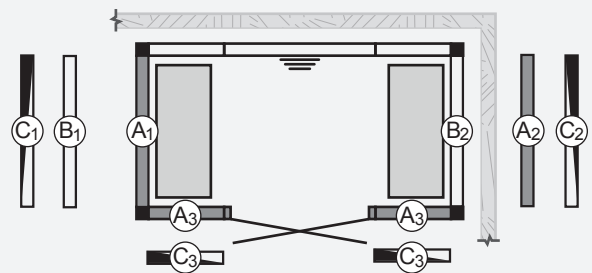

1709 Black
 Item no: 9607 5026
 Meas: 1730mm x 930mm
 No vent: 4.5kW/ with vent: 4.5kW

Panacea steam bath models 1309 and 1709 with steam column

See below for all the standard plans for the compact Panacea steam bath 1309 and 1709. In addition to a choice of several different wall sections as a no cost options and include steam generator and hand & head shower. Also available with shower tray.

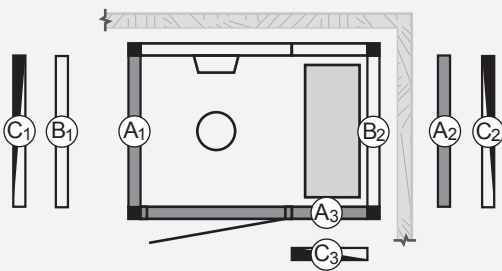



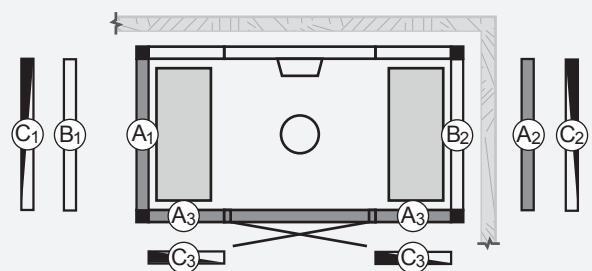

1309 tx/t Black
 Item no: 9607 5028
 Meas: 1330mm x 930mm
 No vent: 2.2kW/ with vent: 4.5kW

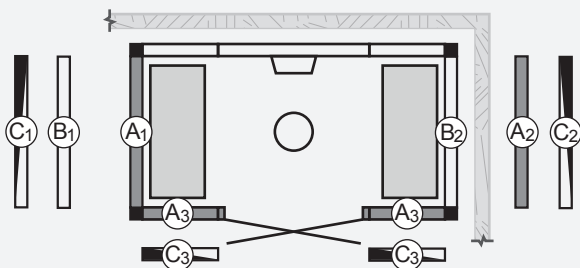

1709 tx/t Black
 Item no: 9607 5030
 Meas: 1730mm x 930mm
 No vent: 4.5kW/ with vent: 4.5kW

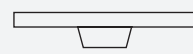
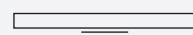

1709 tx Black
 Item no: 9607 5034
 Meas: 1730mm x 930mm
 No vent: 4.5kW/ with vent: 4.5kW

-  Mood lit back section with steam column including steam generator and shower
-  Mood lit back section with steam outlet
-  Transparent smoke colored glass
-  Opaque pale glass/basic (pale tint on the inside, non transparent)
-  Opaque pale glass/black glass (pale tint on the inside, non transparent)

Panacea steam bath optional extras

The Panacea steam bath comes with a whole host of available options to make the steam bath experience an even more pleasurable one. On this page you will find products that are specifically made for perfect integration in the Panacea steam bath.

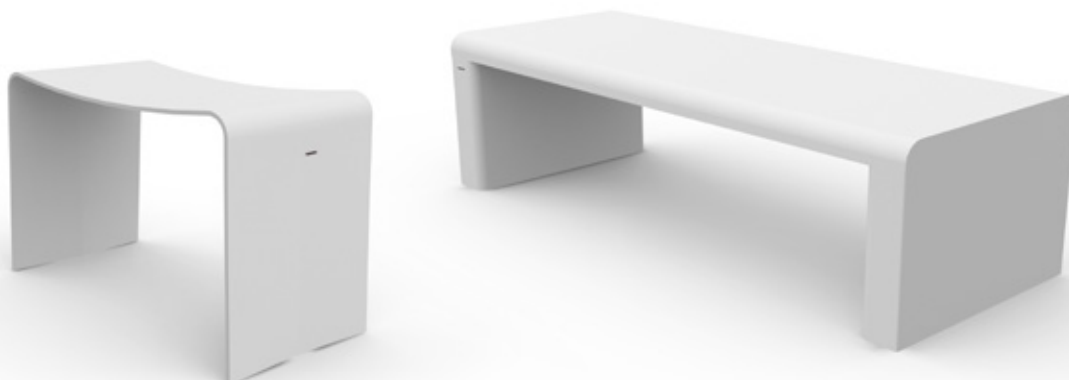

Benches

The benches developed for the Panacea steam bath are made from Corian® – a durable, elegant and hygienic material that through its physical properties are extremely suitable for the Panacea steam bath. The benches are sold separately if extra ones are desired, either adding to the ones included in the steam bath or to enhance the space surrounding the steam bath. There are four different sizes available.

Use the specially developed cleaning kit for Tylö's Corian benches. (Cleaning set Corian item no 9090 3055)

Stool white Corian 166

Item no: 9607 5060
Length: 660 mm
Depth: 310 mm
Height: 450 mm

Bench 1545 Panacea

Item no: 9607 5050
Length: 1545 mm
Depth: 600 mm
Height: 450 mm

Bench 1945 Panacea

Item no: 9607 5052
Length: 1945 mm
Depth: 600 mm
Height: 450 mm

Bench 2345 Panacea

Item no: 9607 5054
Length: 2345 mm
Depth: 600 mm
Height: 450 mm



Sound system

To match the exclusive feel of the Panacea steam bath, we offer a groundbreaking and completely invisible sound system as a possible upgrade. The Microstereo Steam system is a complete set consisting of two speakers and one amplifier, fully compatible with all popular sound formats via air play from your own sound device. The system is also equipped with a FM receiver and two aux ports.



Easy assembly and installation

The Panacea steam bath is constructed with convenience and easy installation in mind. Thanks to modular thinking and a unique assembly system, patented by Tylö, the steam bath sections are simply snapped together without any further fixtures or tools required. The bottom frame of the steam bath is equipped with adjustable feet and installation is usually completed within hours rather than days. For improved performance and steam distribution, we recommend installing a heated floor of the steam bath as well as making sure that the space is well ventilated. For run times in excess of three hours, we recommend installing an insulated ceiling in the steam bath. For run times in excess of five hours, the heated ceiling option is recommended for optimal performance.