

LIBERA

Installation manual

Dimensions:

120x180 cm

150x180 cm

150x200 cm

200x200 cm

200x250 cm

Handedness:

Left

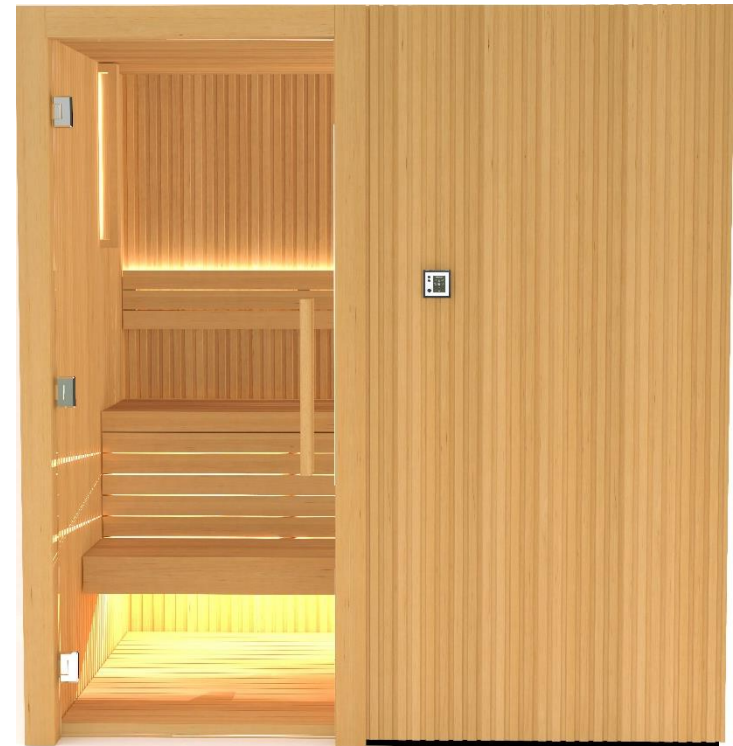

Leave space for better assembly

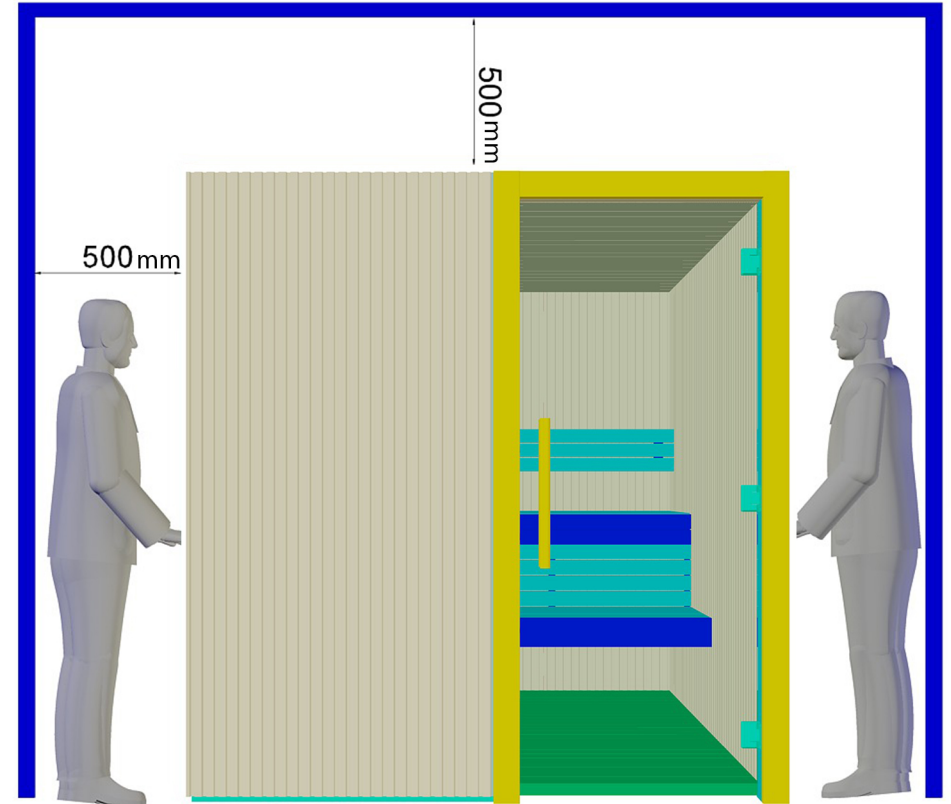
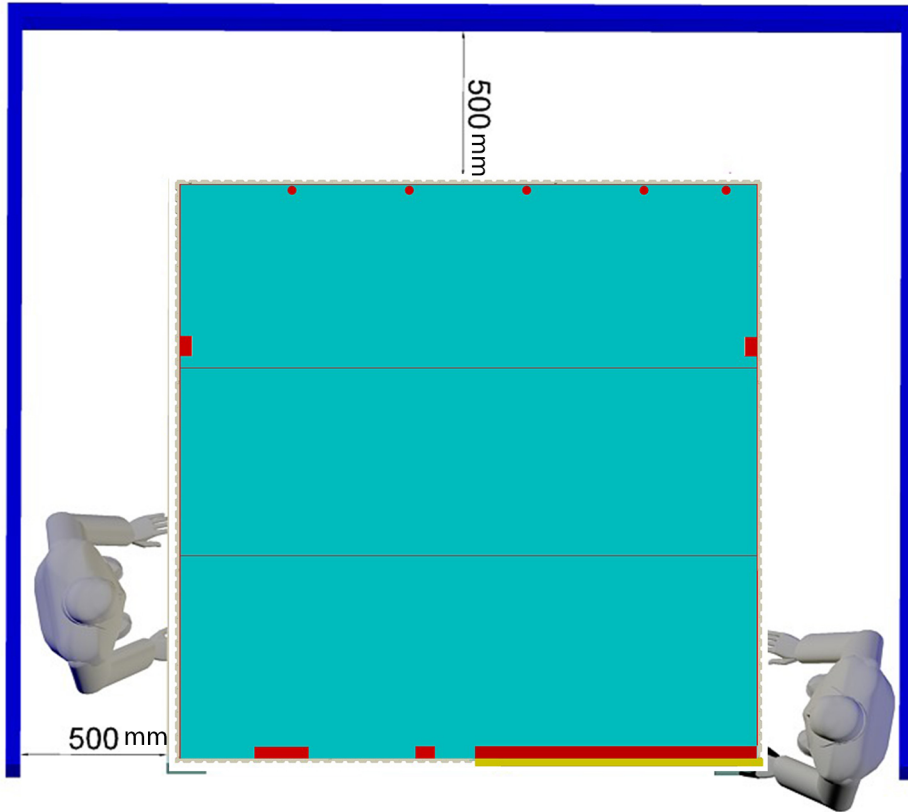

Tools

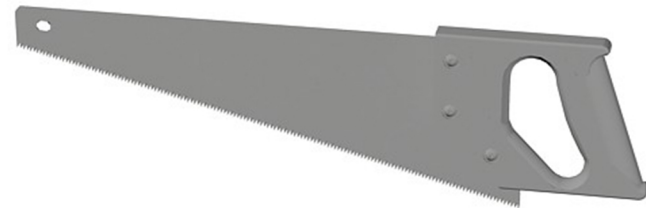
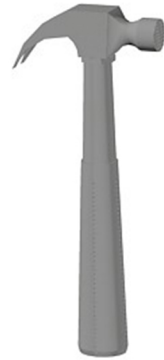
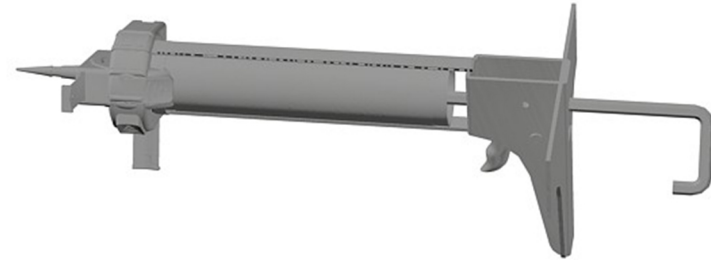

1. Base frame

	x (mm)	y (mm)
120x180 cm	2115	1770
150x180 cm	2293	1770
150x200 cm	2451	1970
200x200 cm	2778	1970
200x250 cm	3152	2470

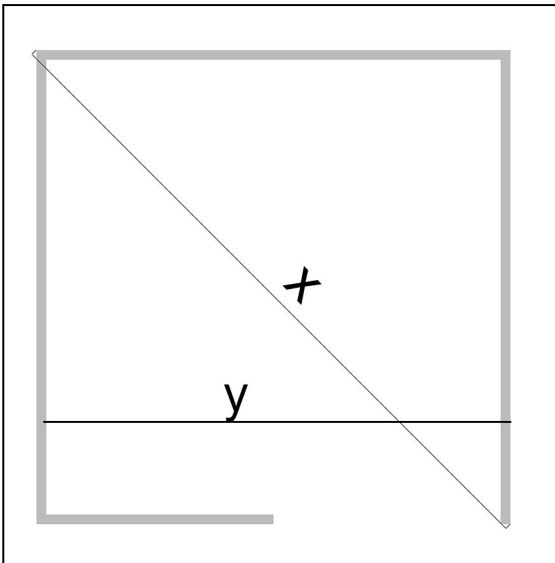
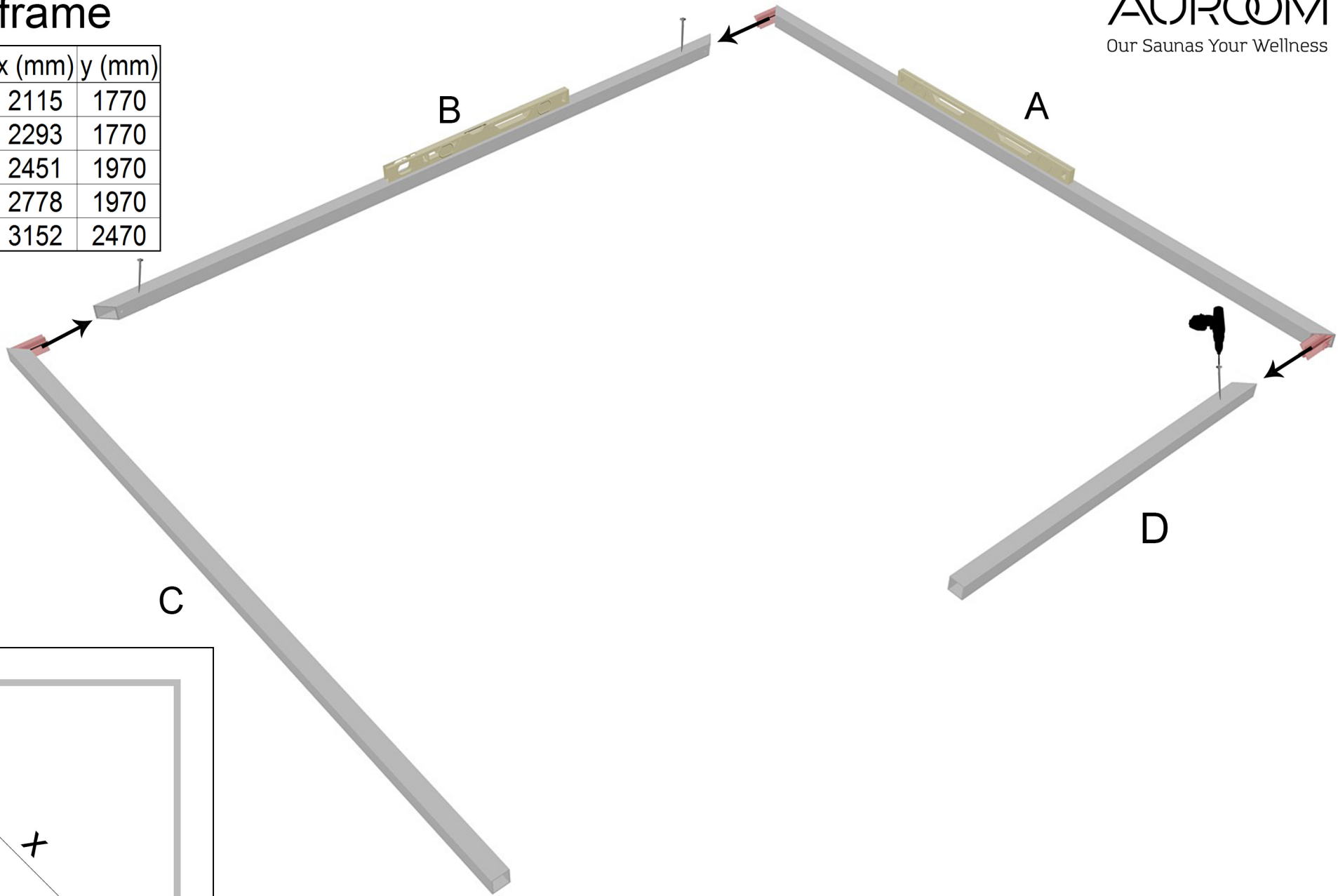

2. Walls

	Number of wall elements			
	A	B	C	D
120x180 cm	2	3	2	2
150x180 cm	2	3	2	2
150x200 cm	2	3	2	2
200x200 cm	3	3	3	2
200x250 cm	3	4	3	3

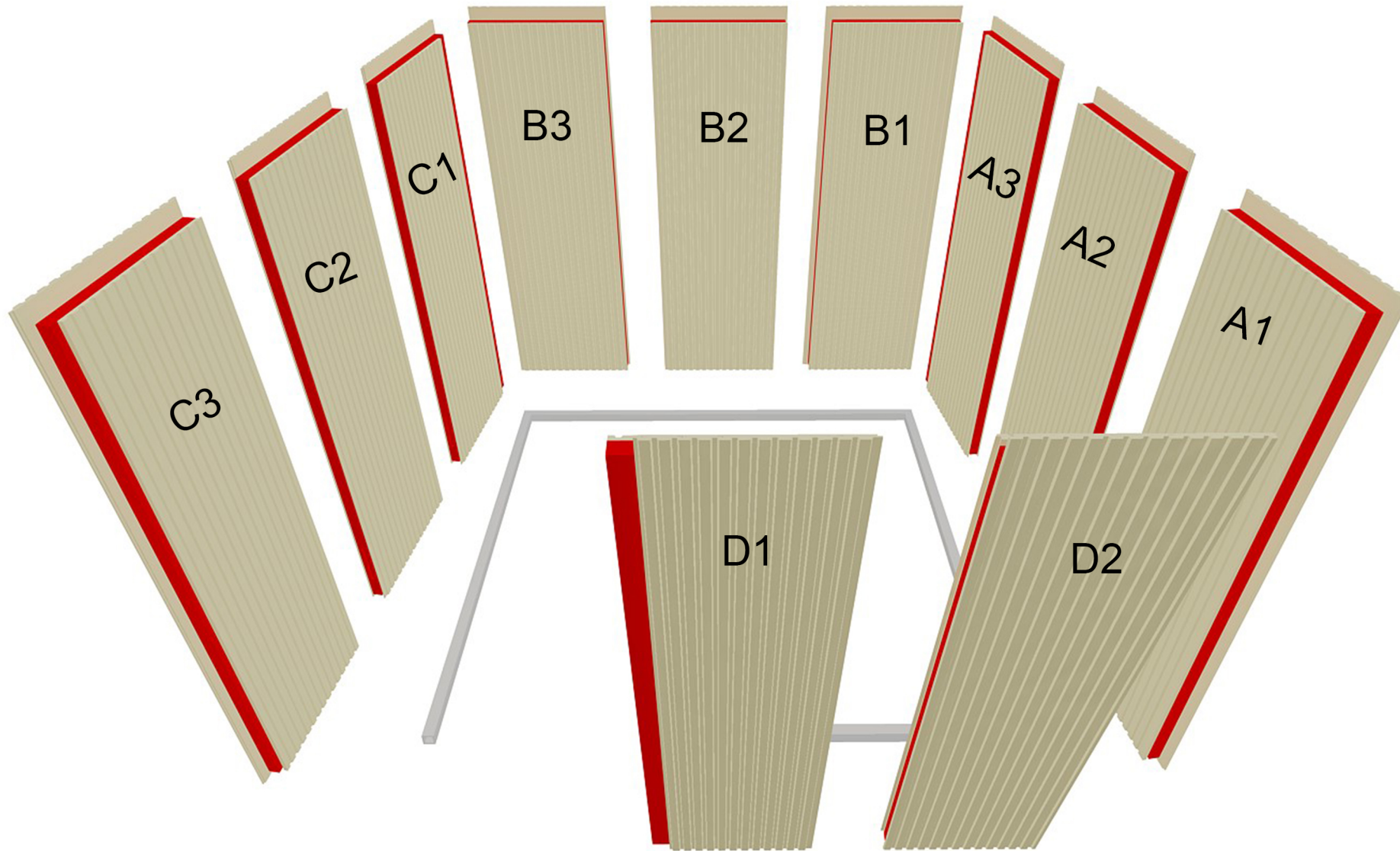

3. Multiclip closing system

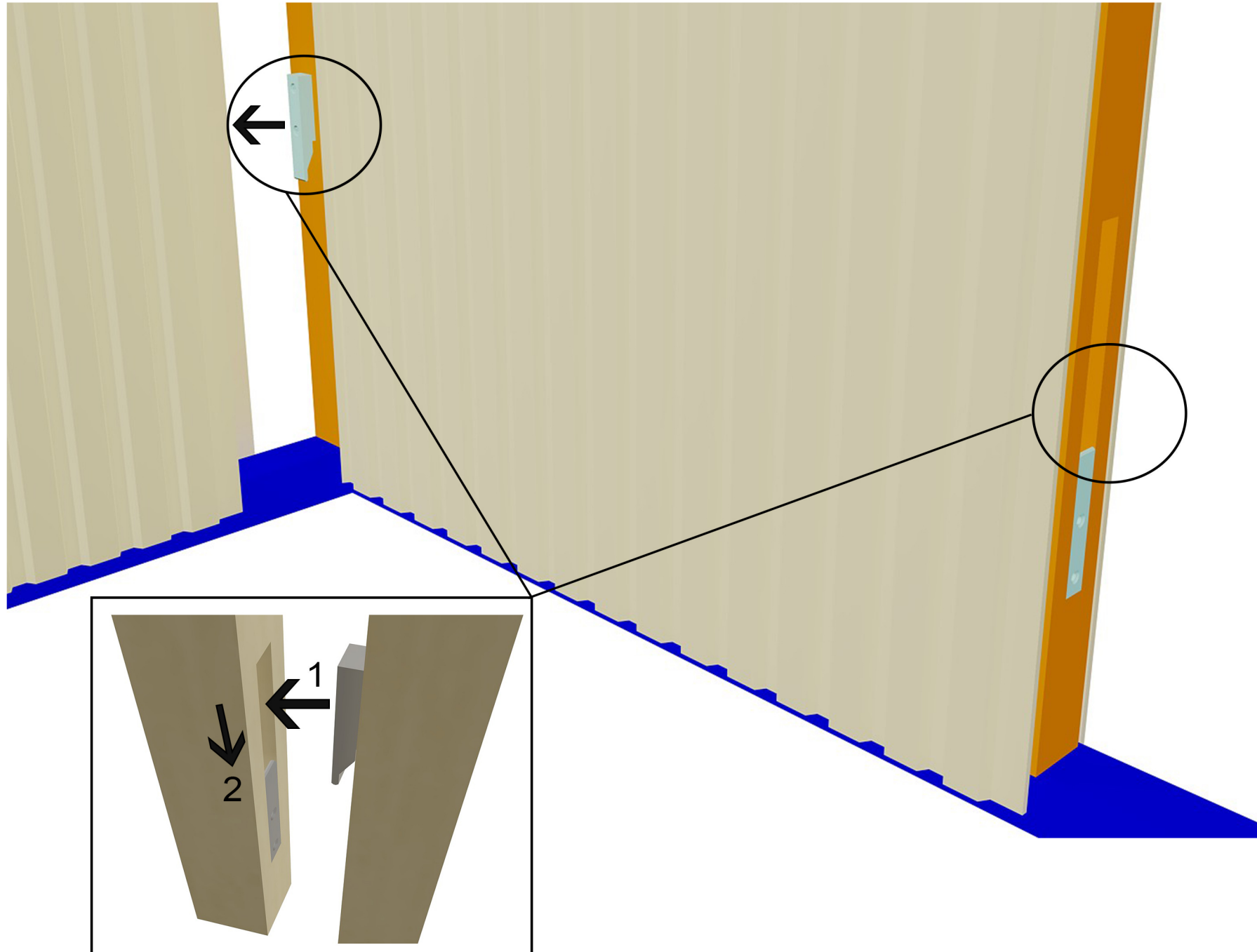

4. Fixing first corner walls

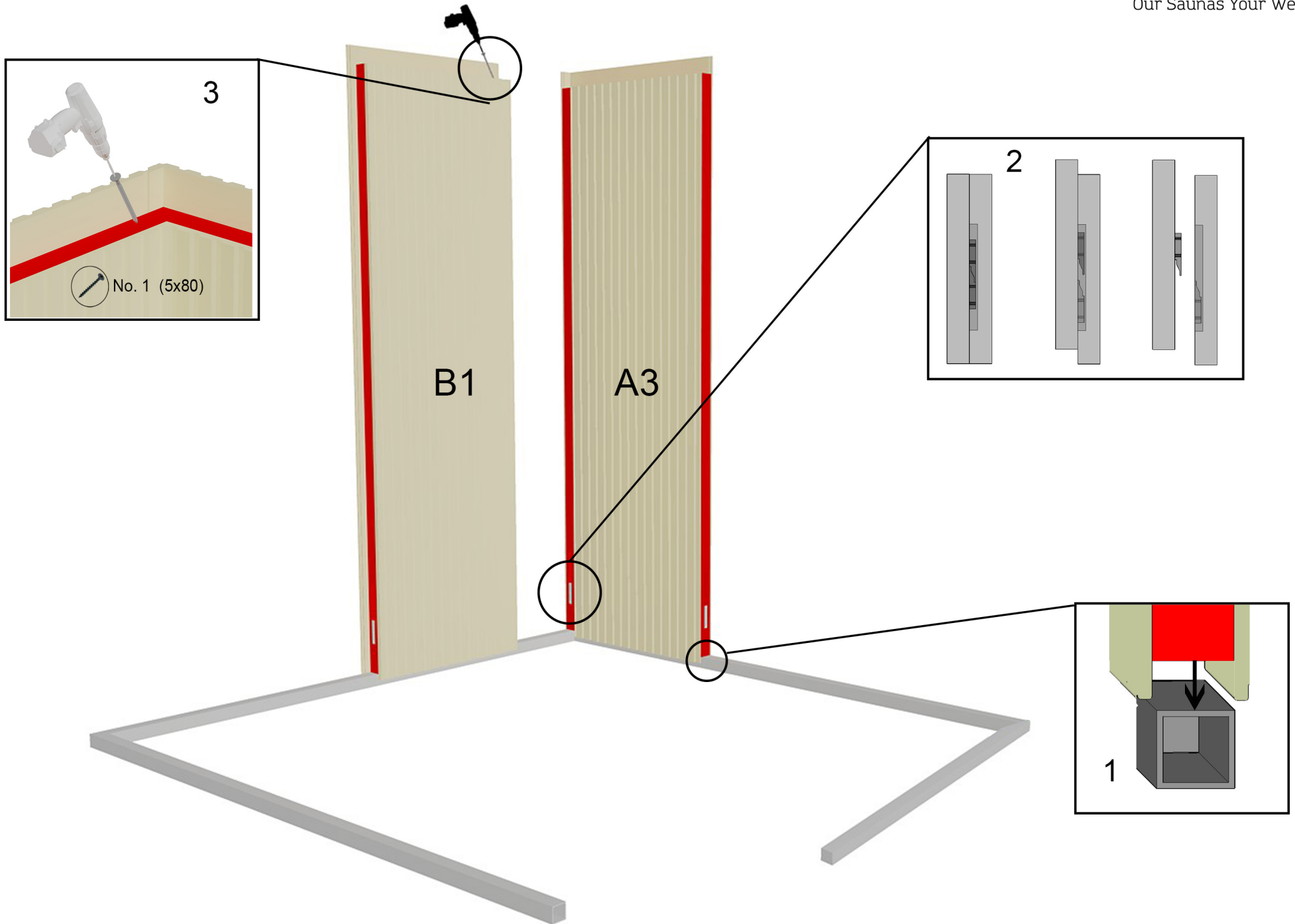

5. Fixing walls A1 & A2

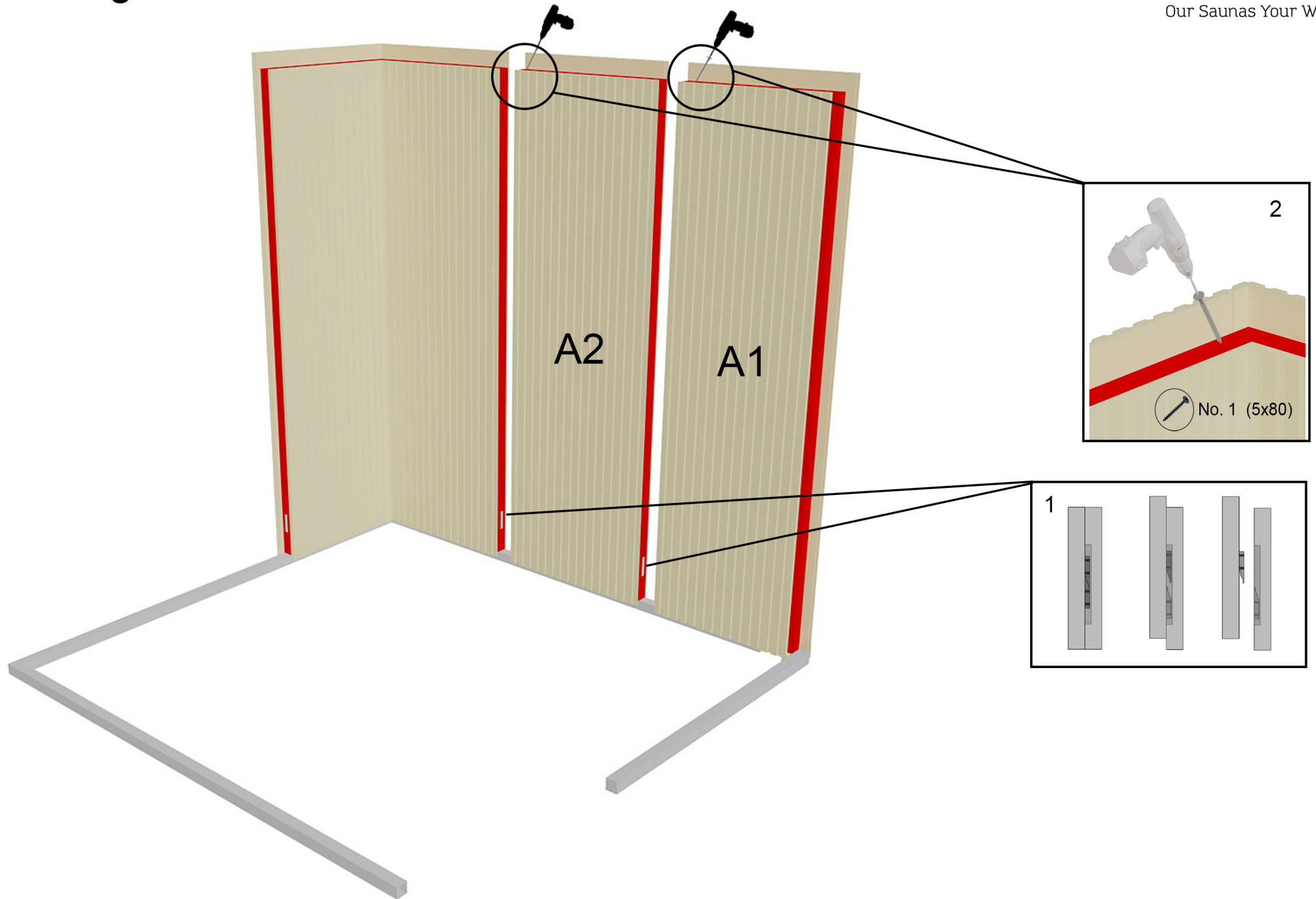

6. Fixing walls B2 & B3

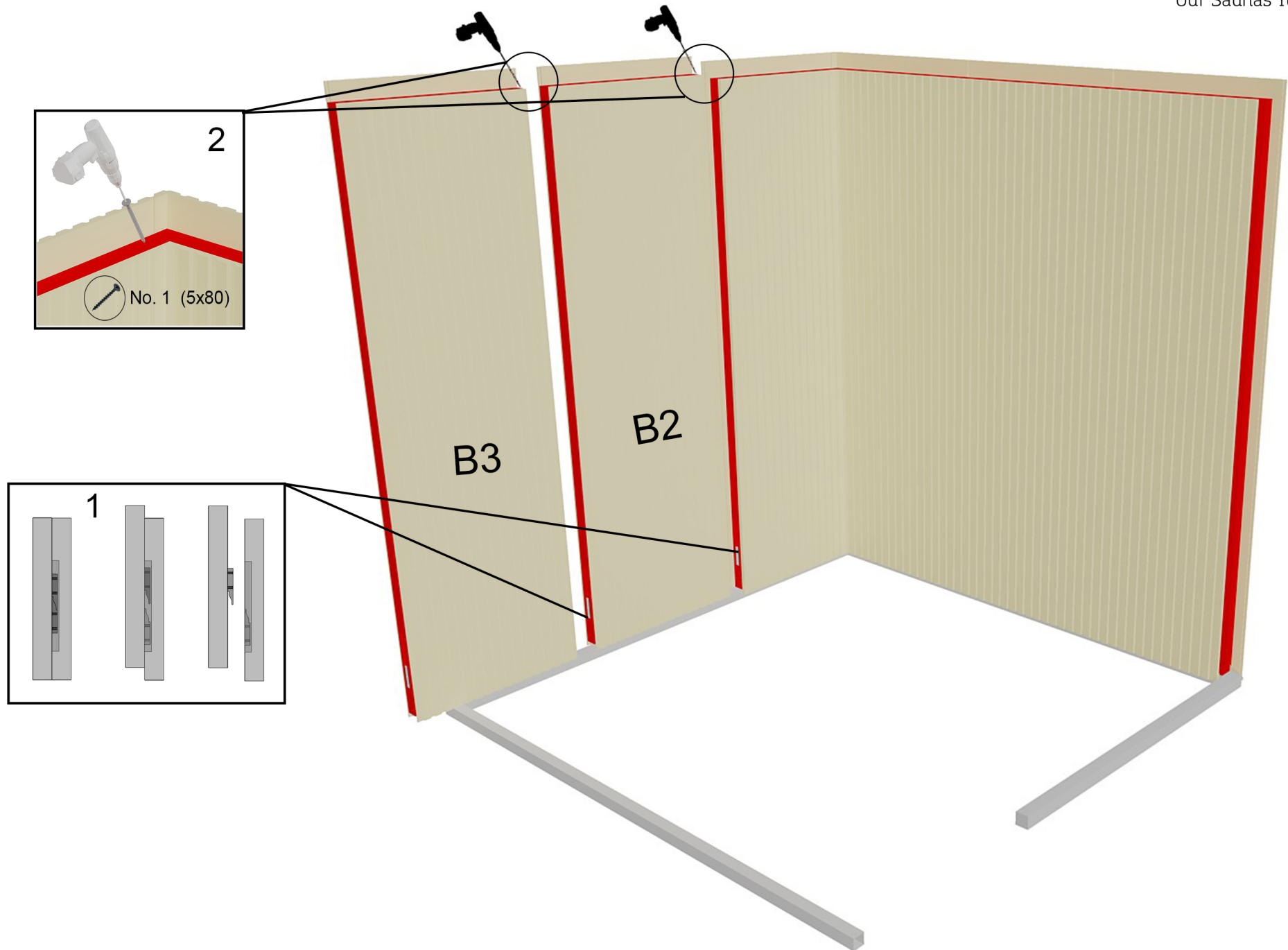

7. Fixing walls C1 & C2 & C3

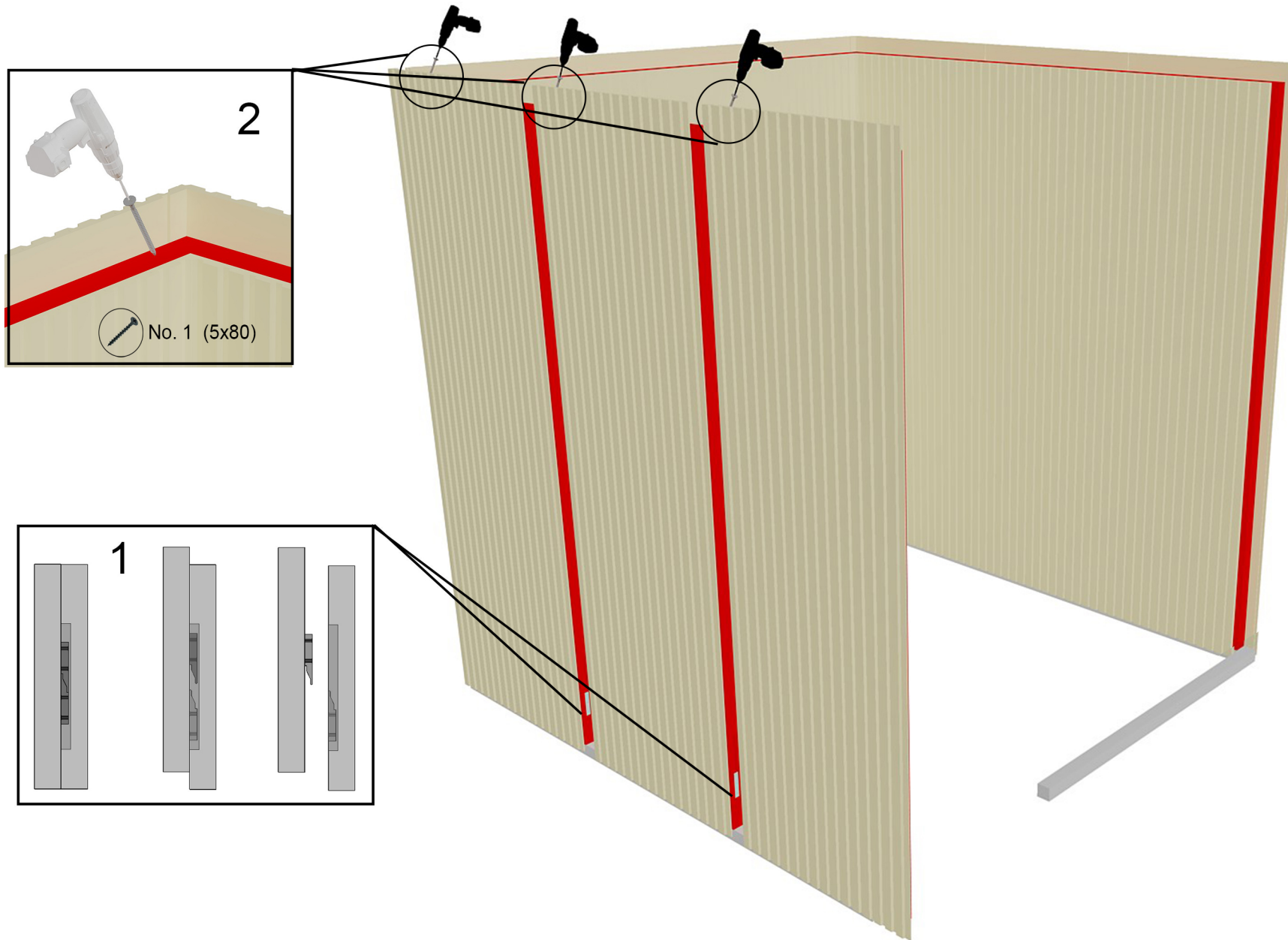

8. Fixing walls D1 & D2

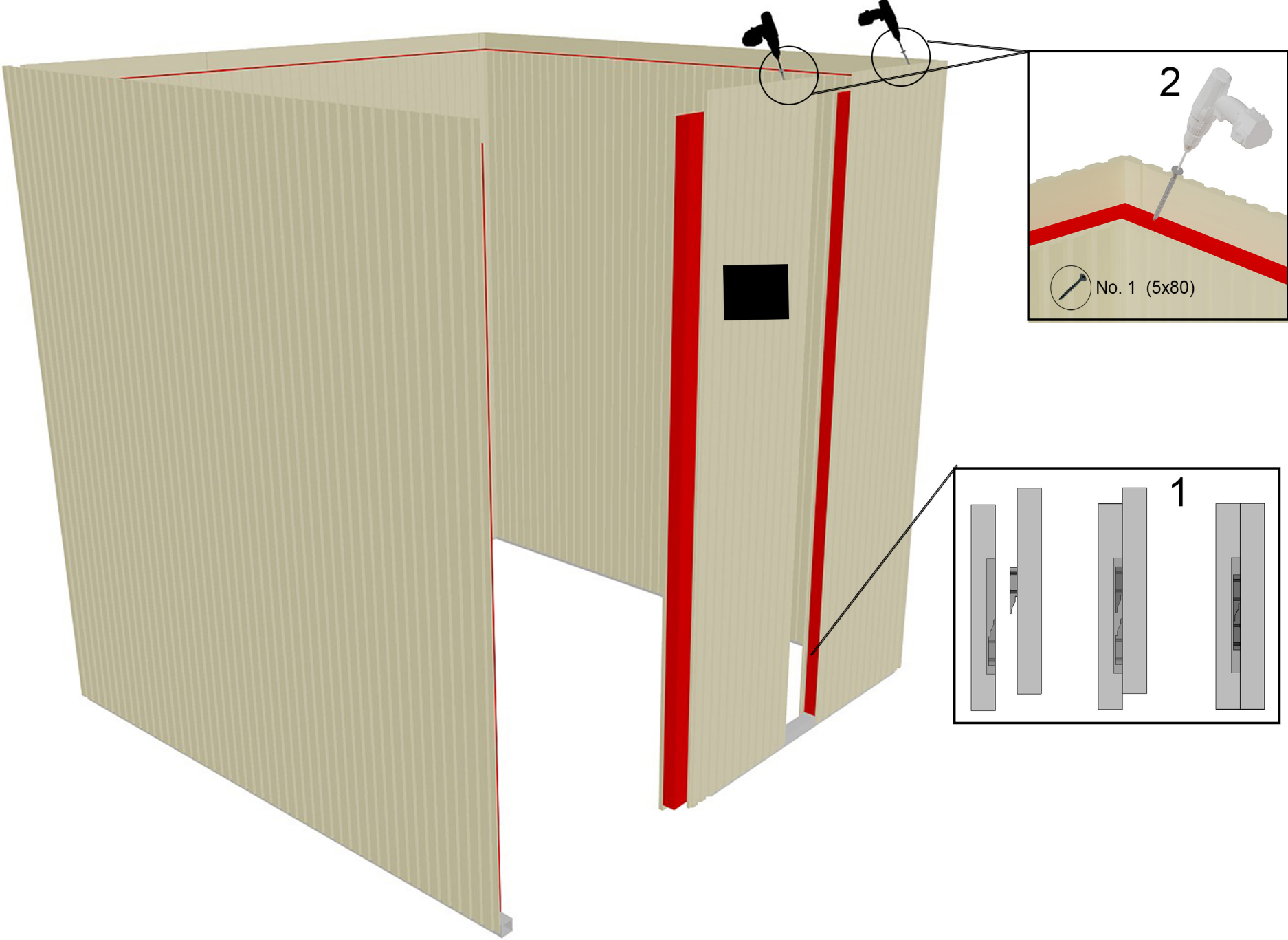

9. Fixing ceilings

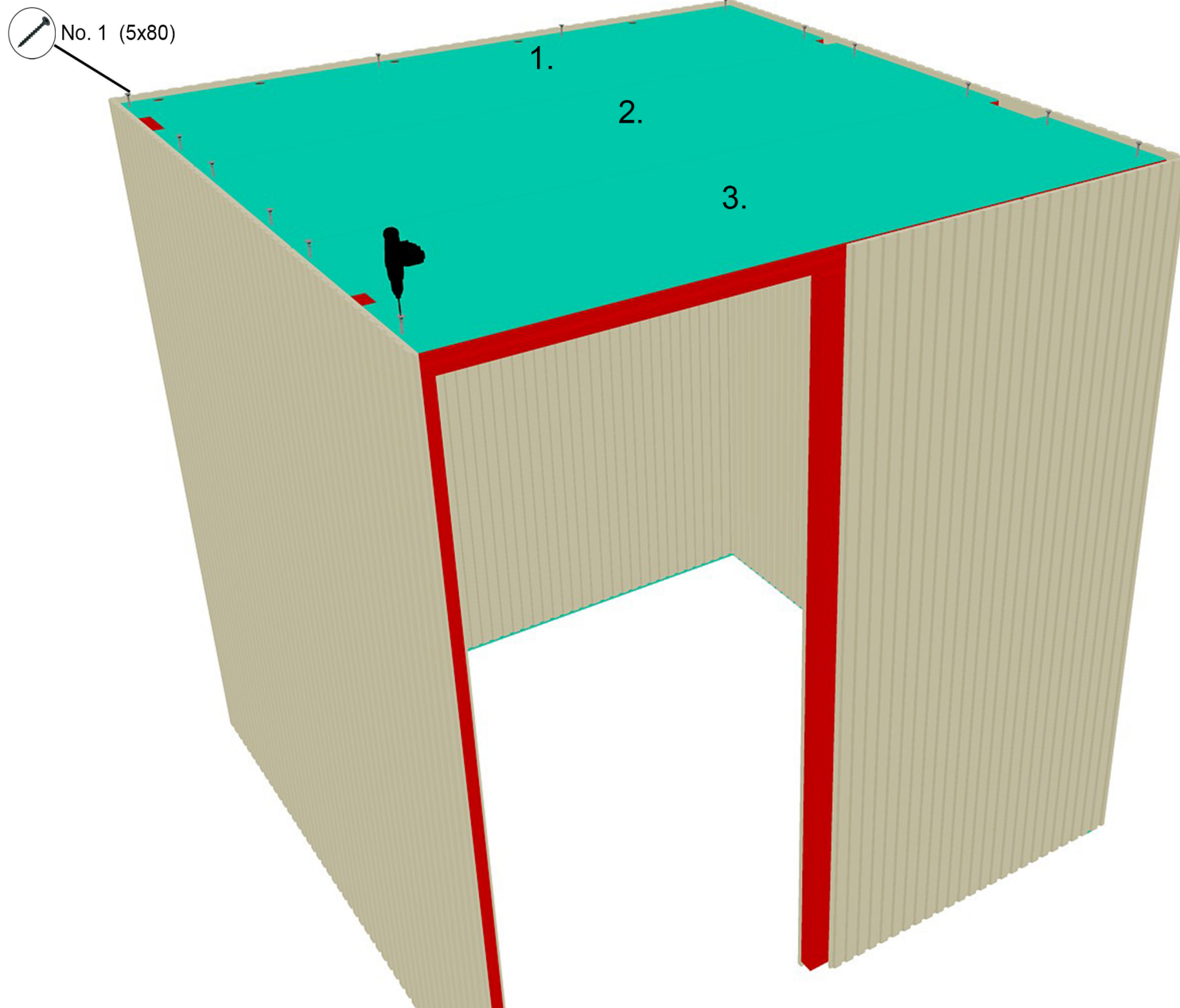

10. Interior
150x180 cm
150x200 cm
200x200 cm

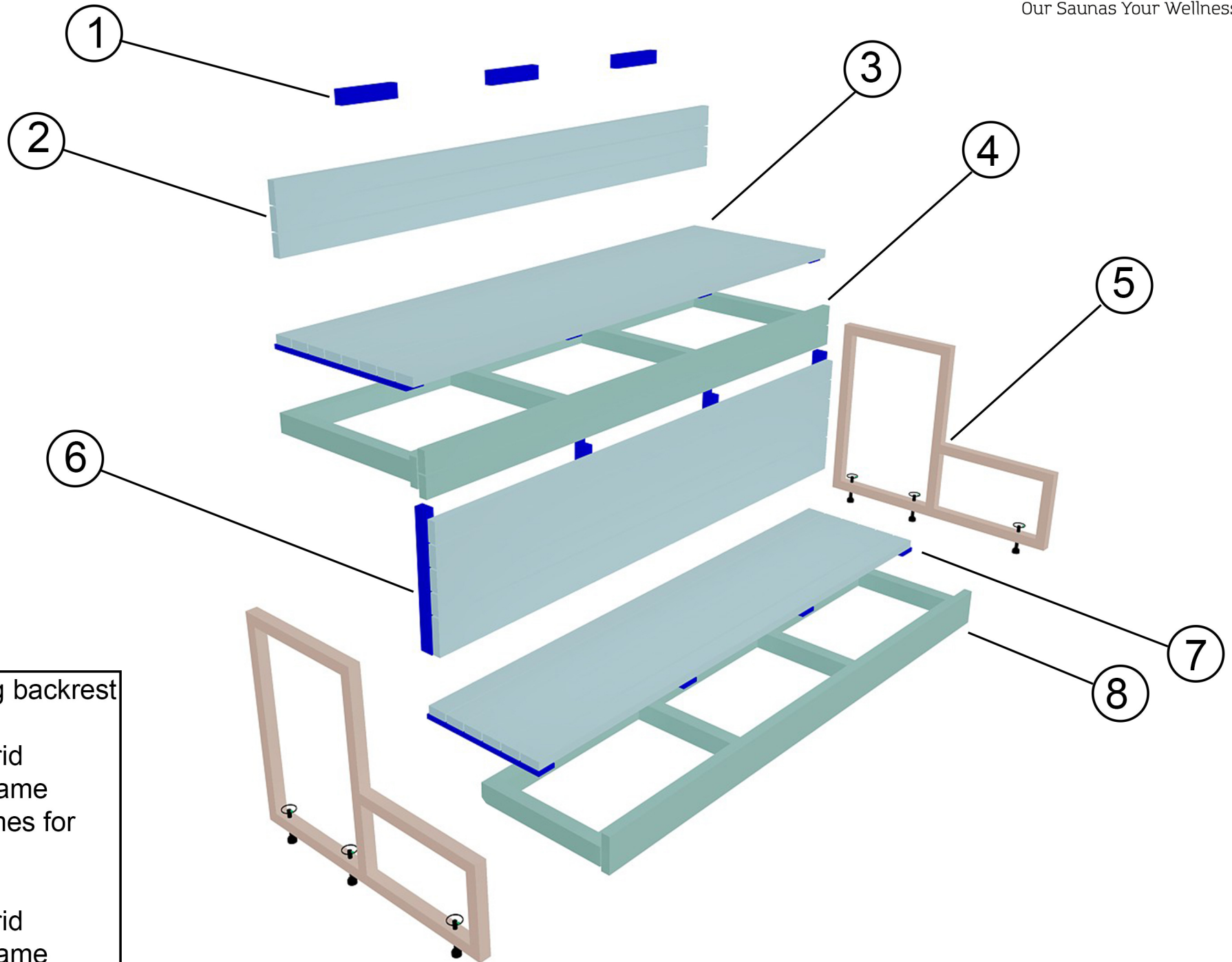

1. Blocks for fixing backrest
2. Backrest
3. Upper bench grid
4. Upper bench frame
5. Assistance frames for fixing benches
6. Bench skirt
7. Lower bench grid
8. Lower bench frame

10.1 Interior 120x180 cm

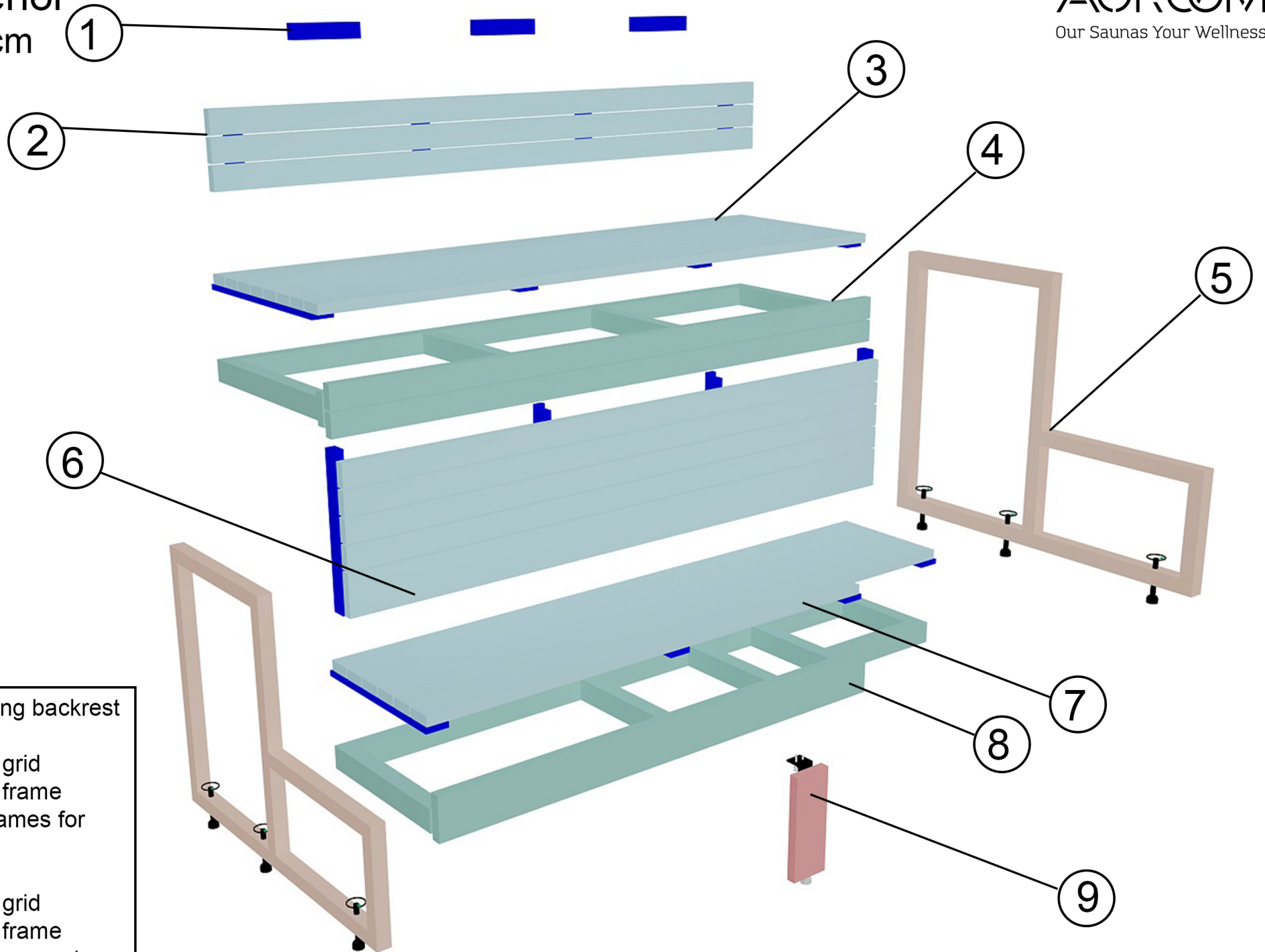

- 1. Blocks for fixing backrest
- 2. Backrest
- 3. Upper bench grid
- 4. Upper bench frame
- 5. Assistance frames for fixing benches
- 6. Bench skirt
- 7. Lower bench grid
- 8. Lower bench frame
- 9. Lower bench support

10.2 Interior 200x250 cm

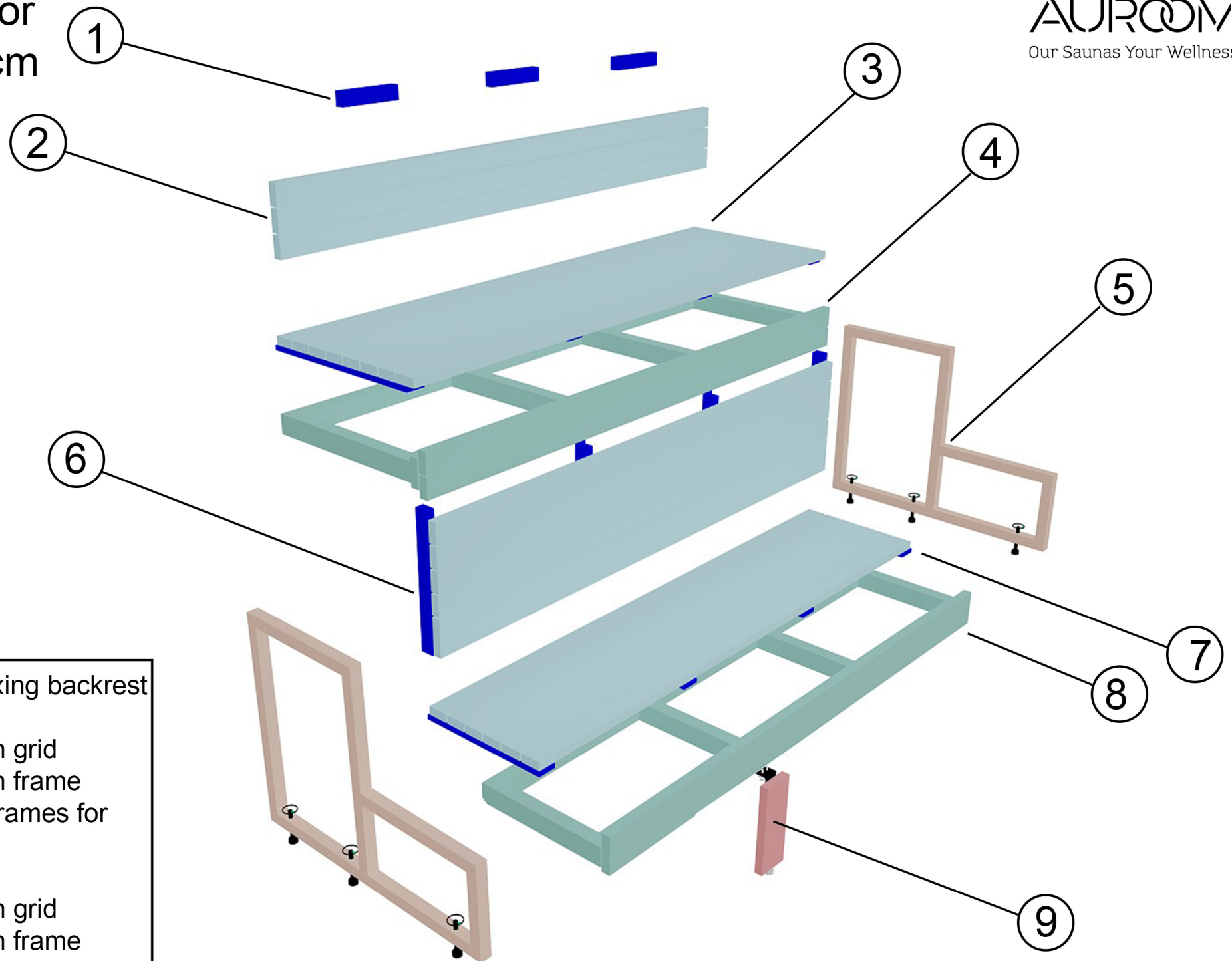

1. Blocks for fixing backrest
2. Backrest
3. Upper bench grid
4. Upper bench frame
5. Assistance frames for fixing benches
6. Bench skirt
7. Lower bench grid
8. Lower bench frame
9. Lower bench support

11. Assistance frames

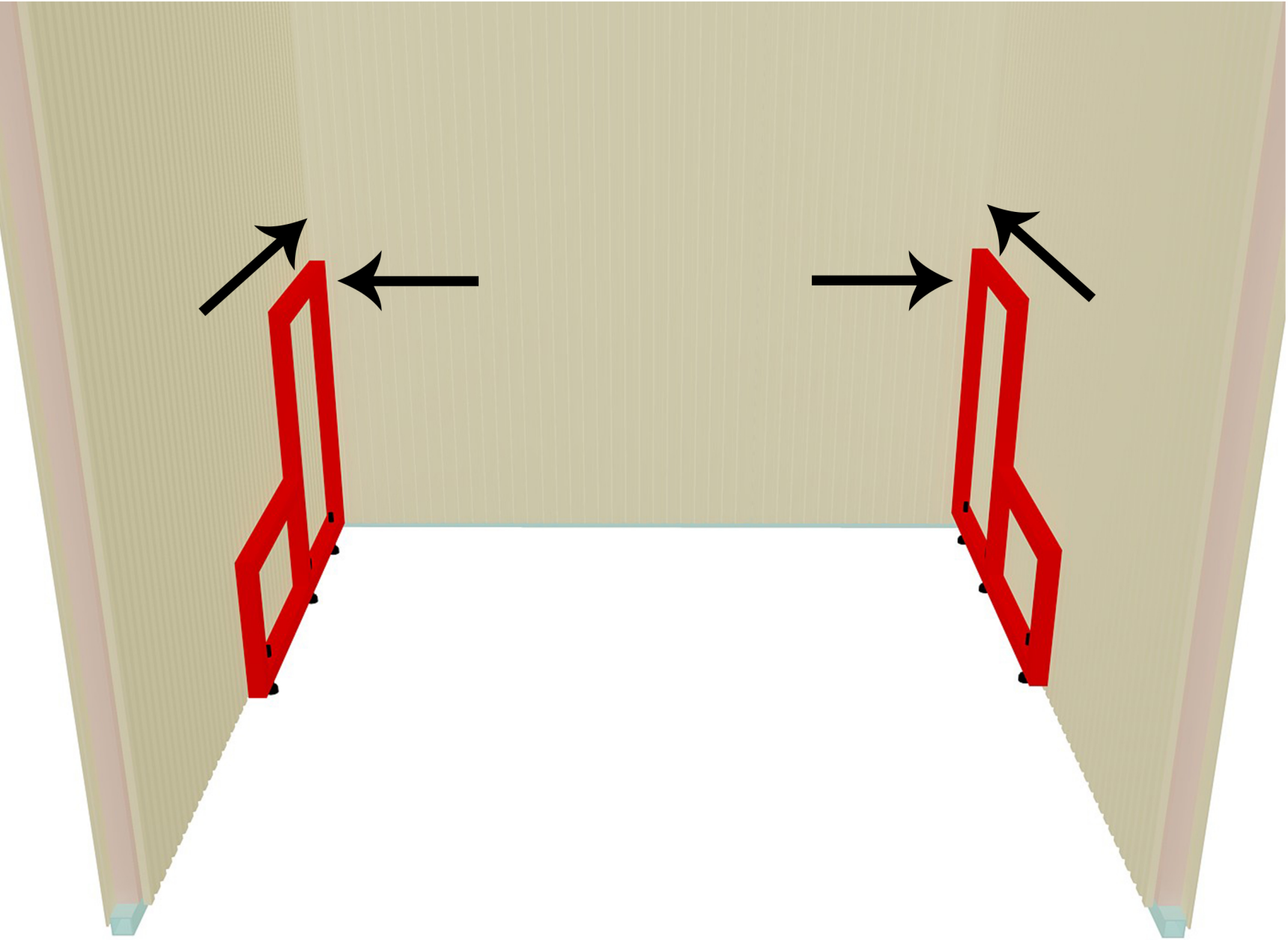

12. Bench support installing

120x180 cm

150x180 cm

150x200 cm

200x250 cm

Pre-marked stripes

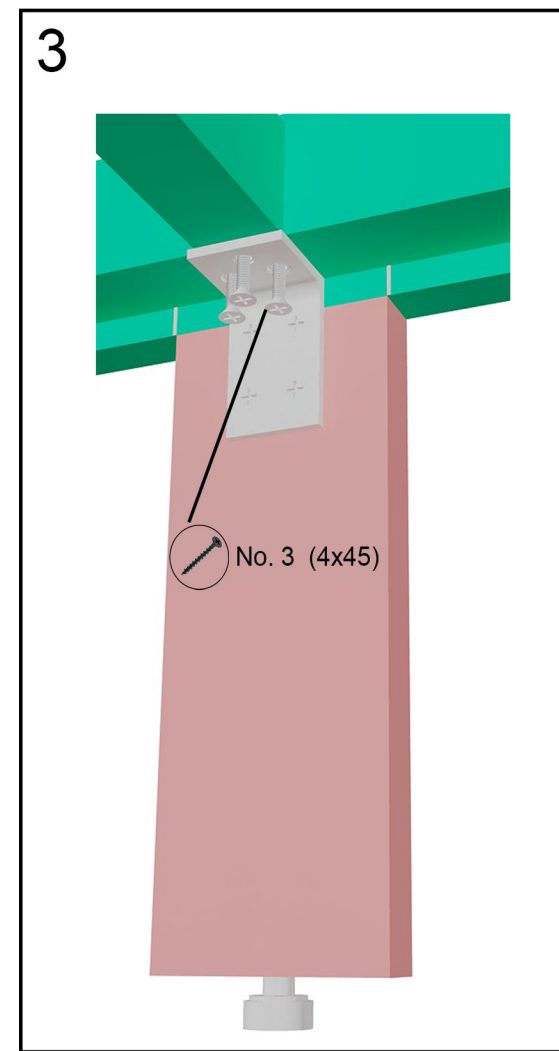
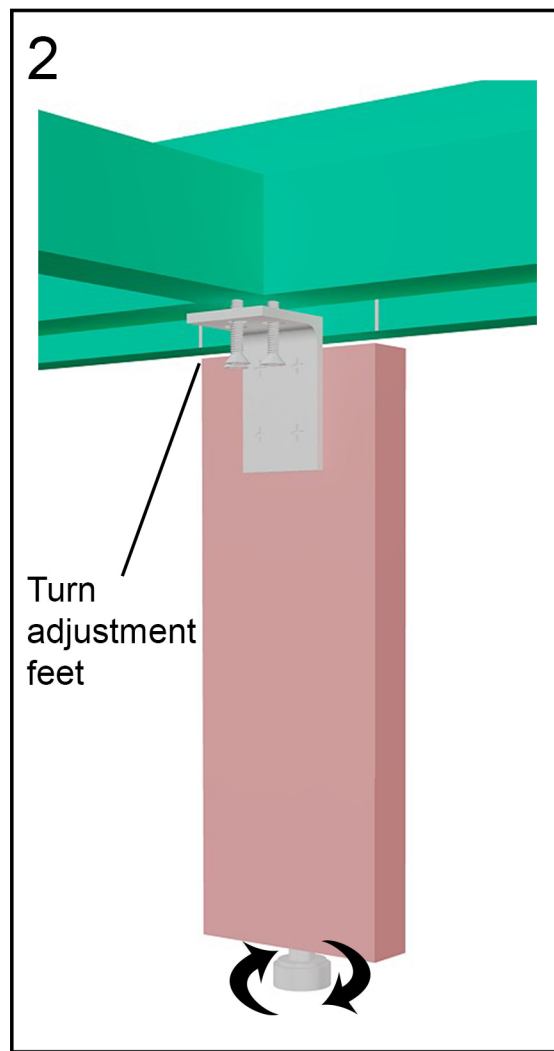
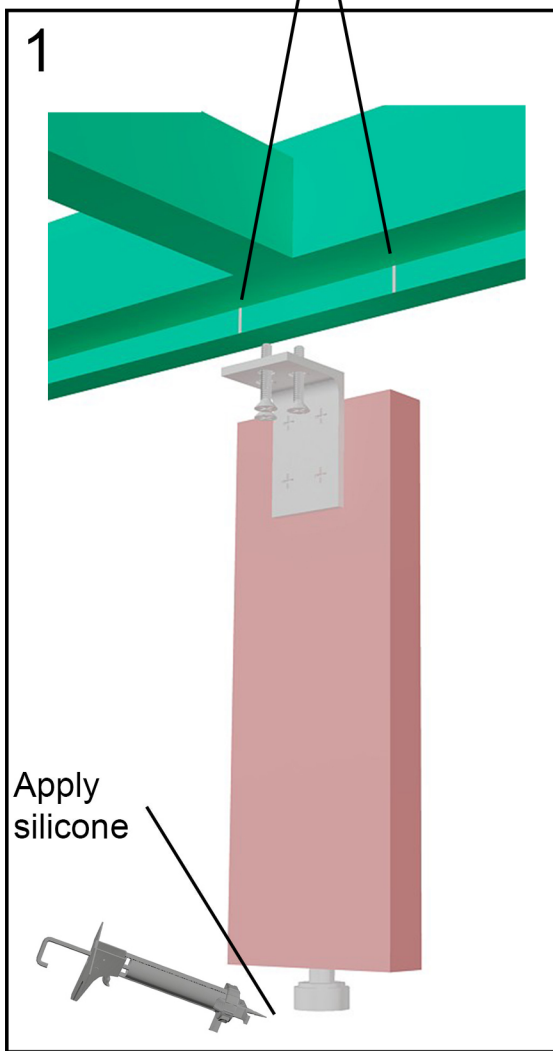

13. Bench frames and backrest blocks fixing

150x180 cm

150x200 cm

200x200 cm

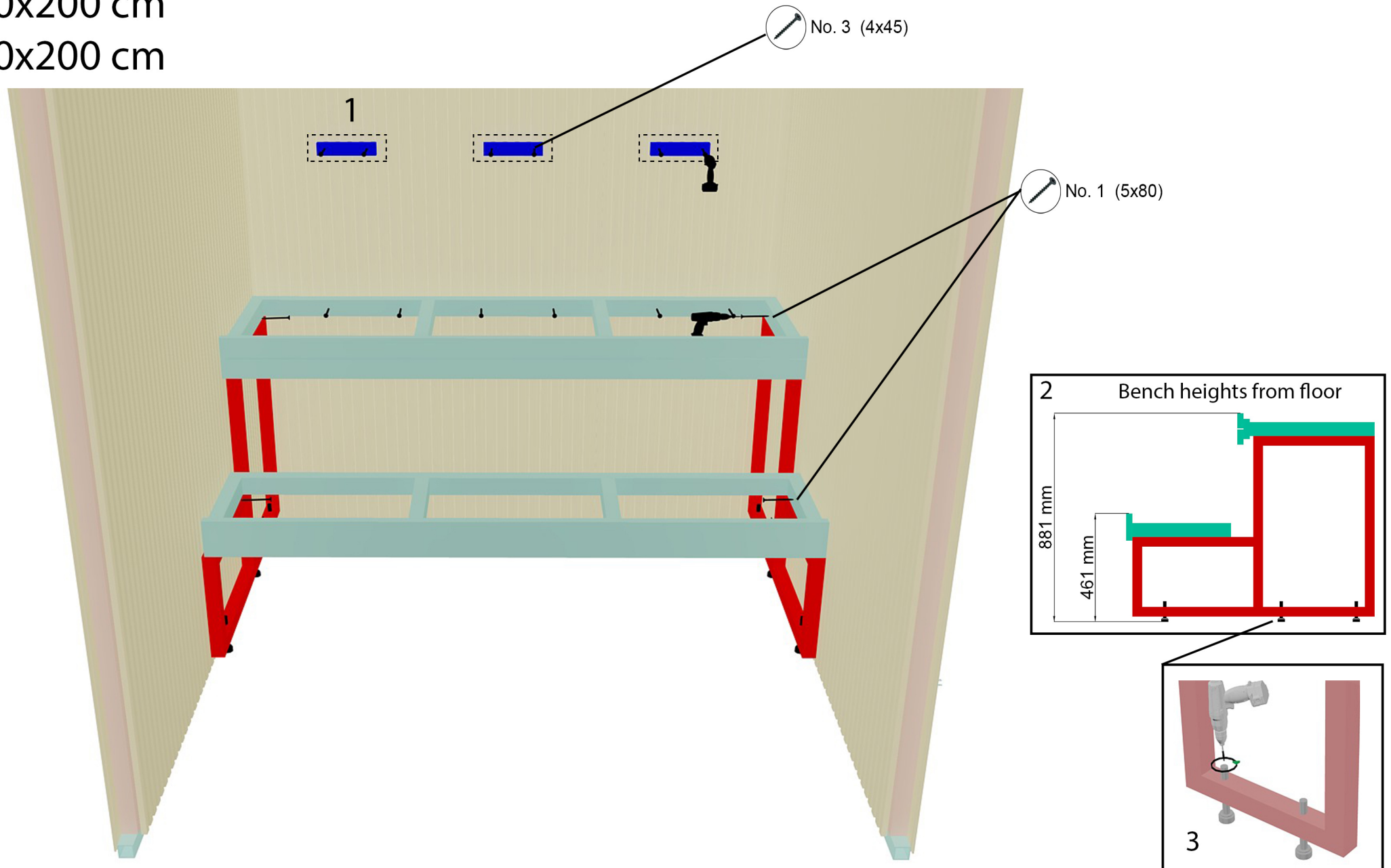

13.1 Bench frames and backrest blocks fixing 120x180 cm

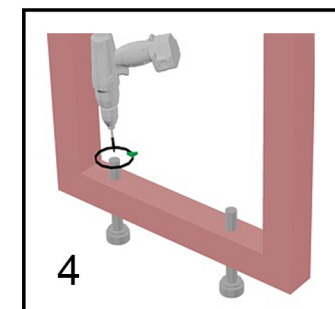
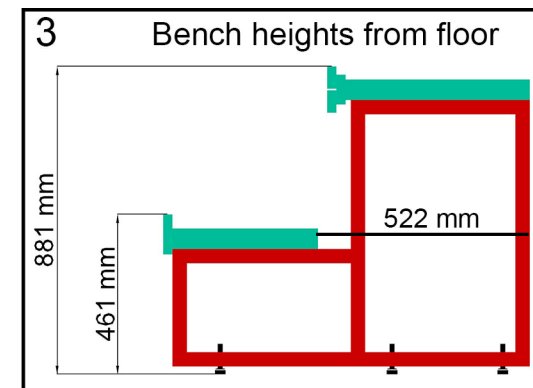
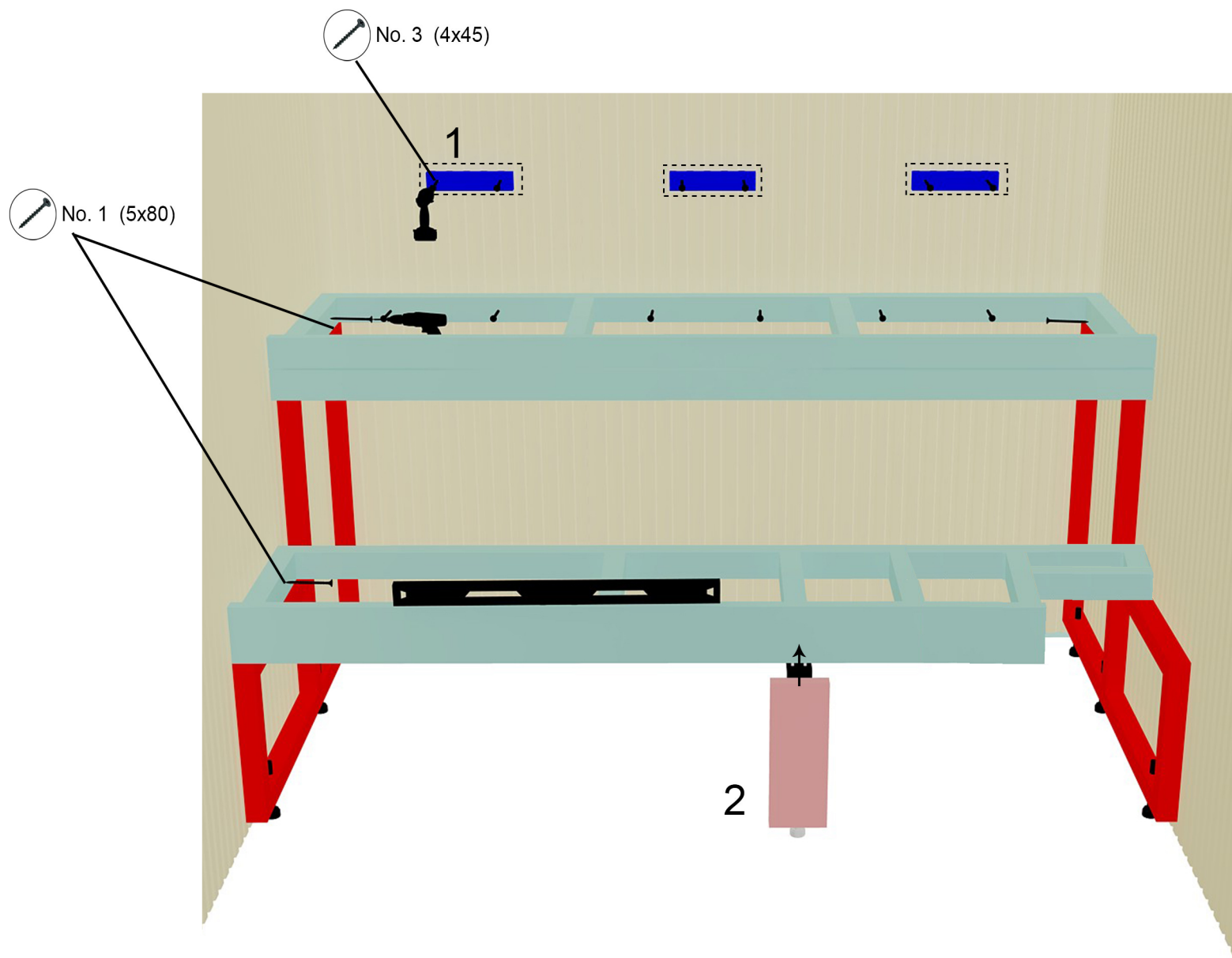

13.2 Bench frames and backrest blocks fixing 200x250 cm

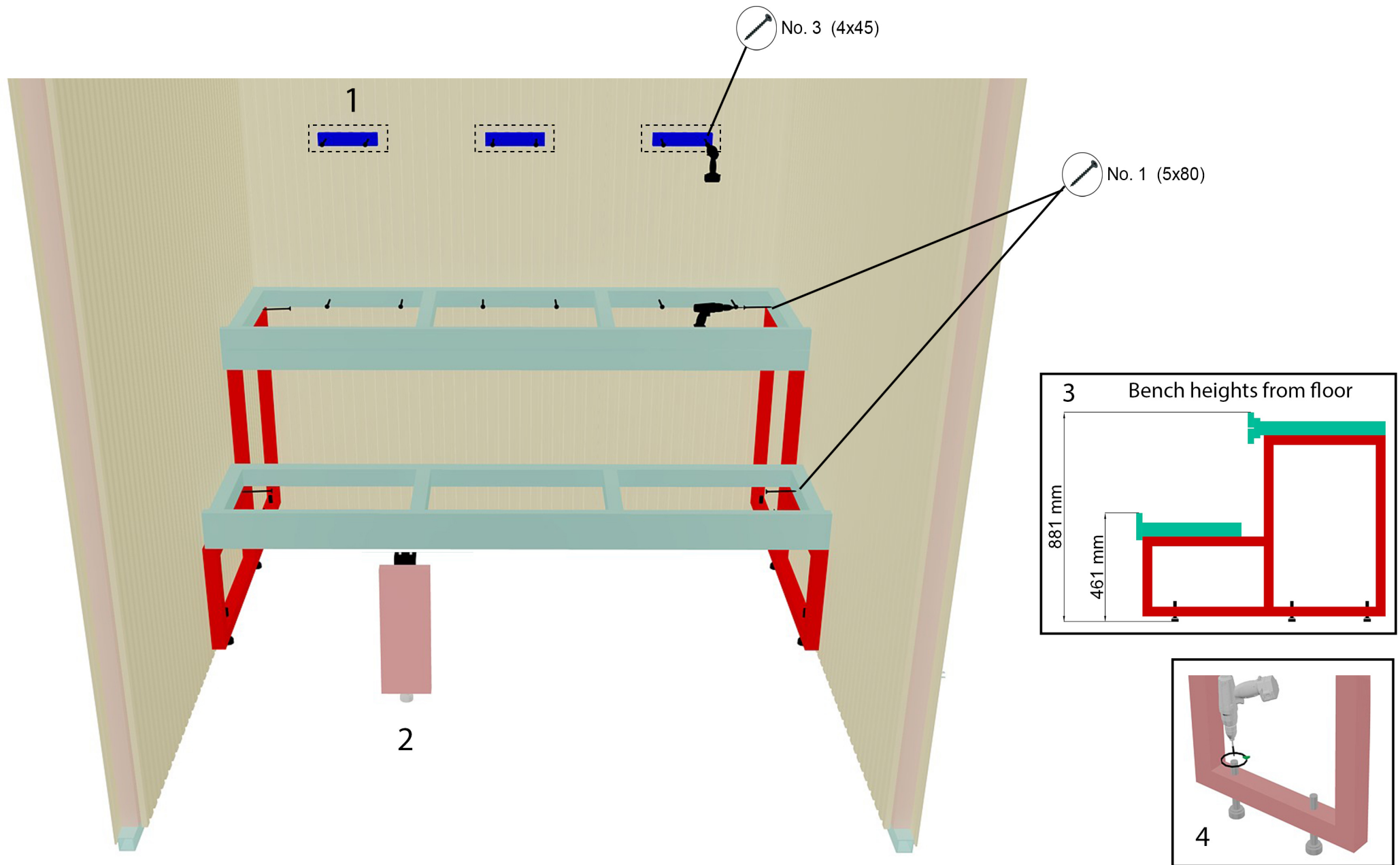

14. Removing assistance frames

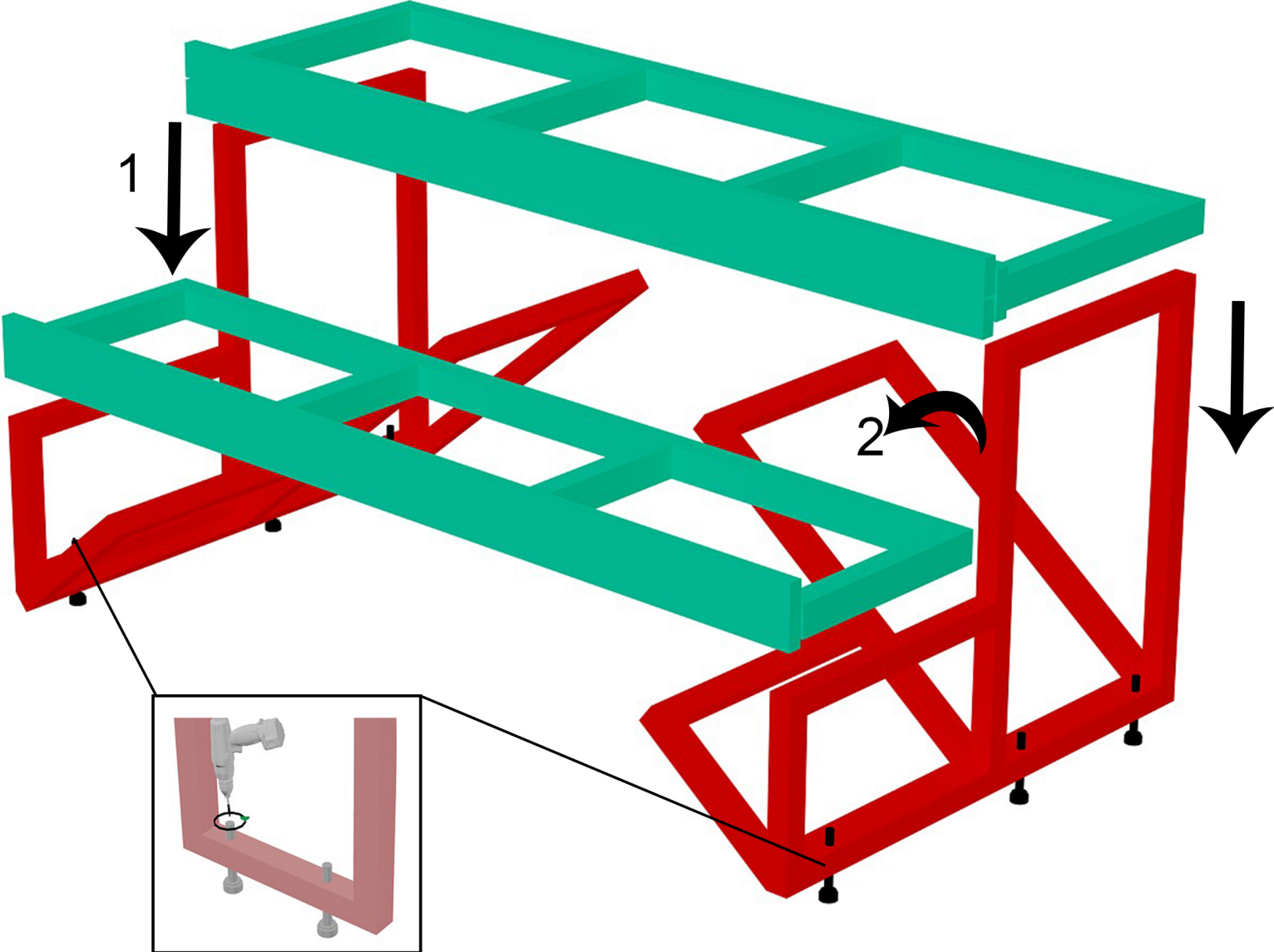

15. Wiring inside walls



1. Push down wires from precut holes on ceiling

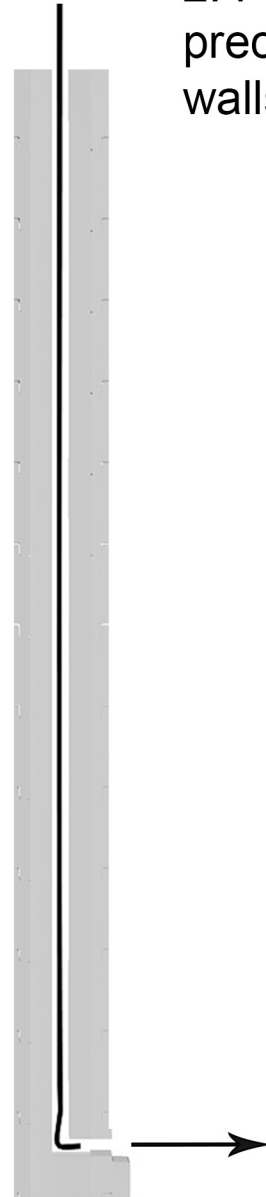

2. Pull out wires from precut holes in the walls

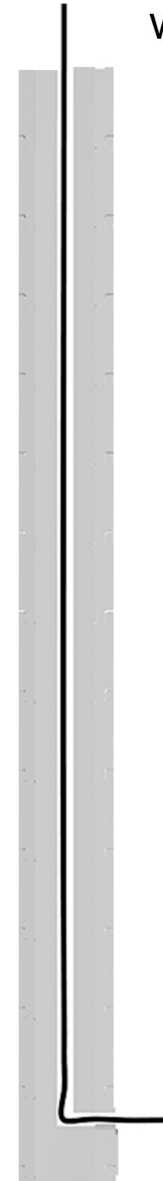

3. Connect wires

16. Connecting LED-strips

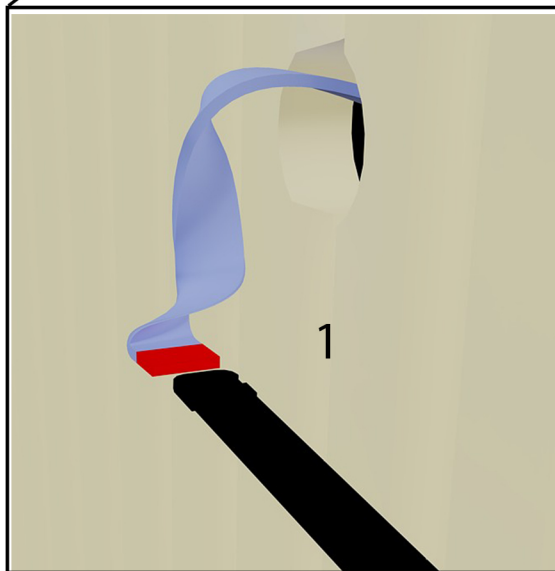
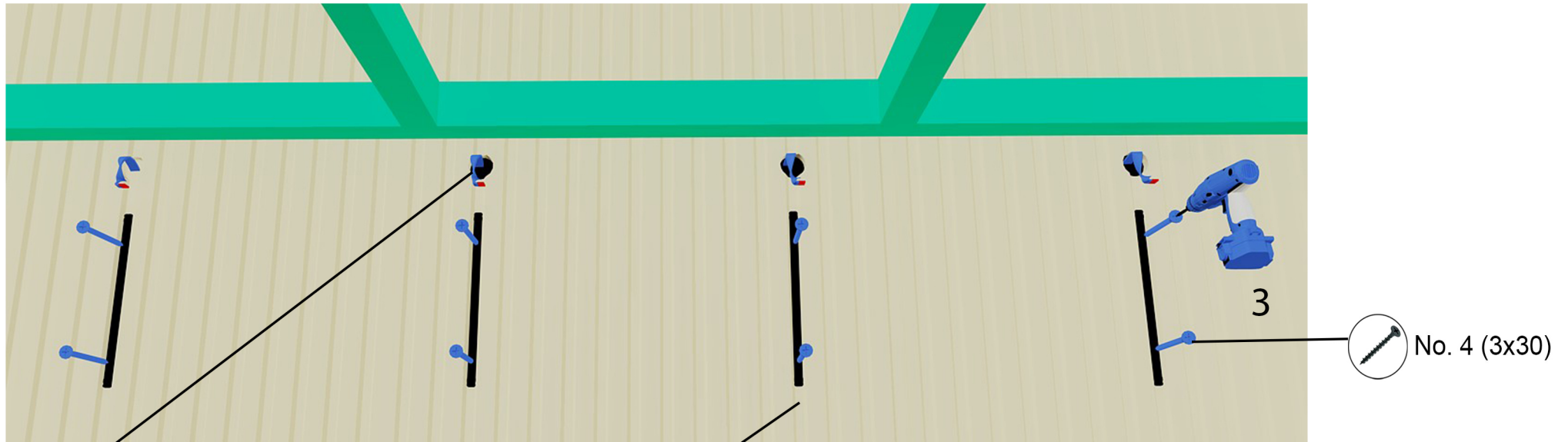

! Always use certified electrician

17. Fixing bench skirt

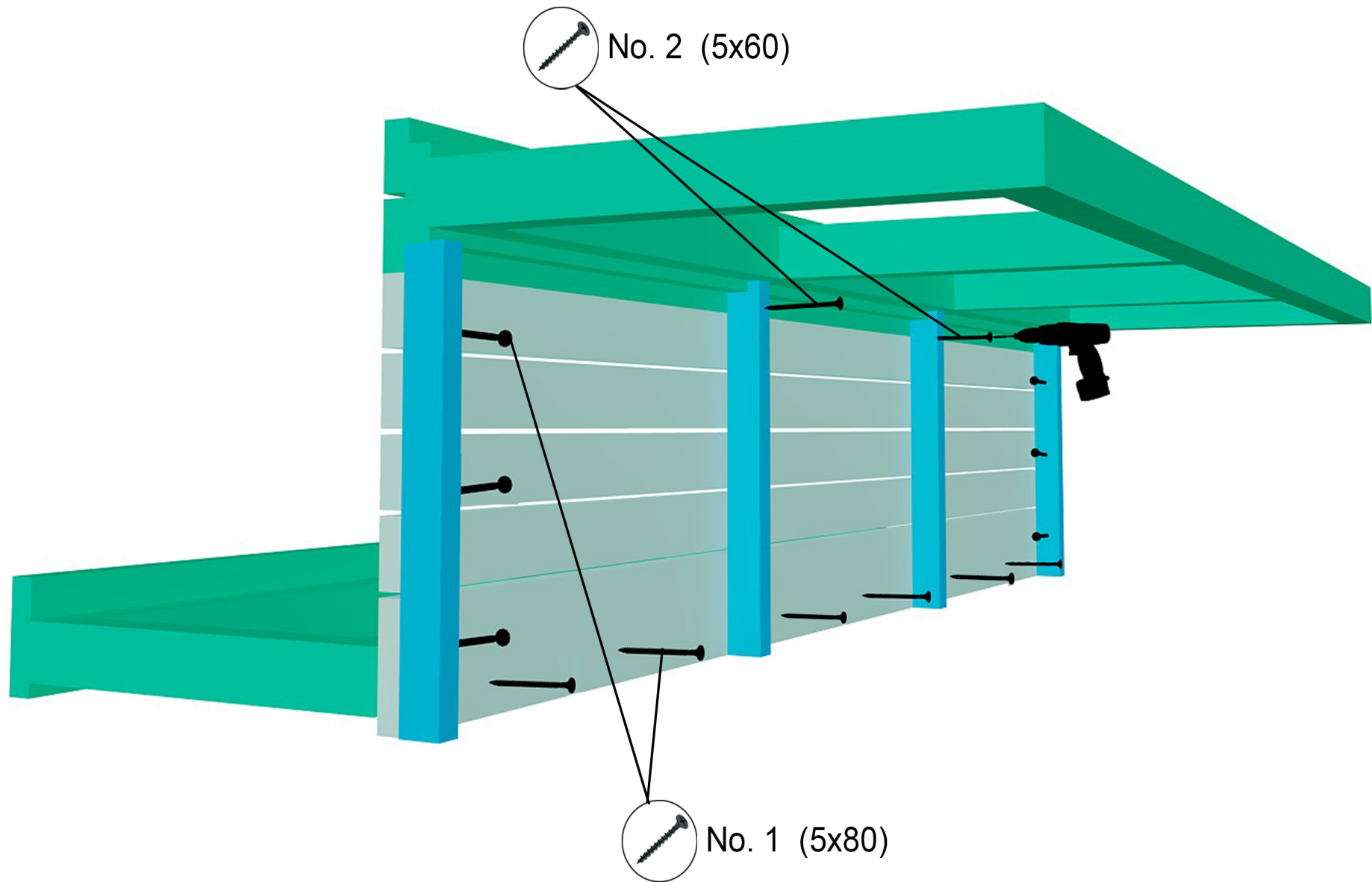

18. Backrest & bench grids

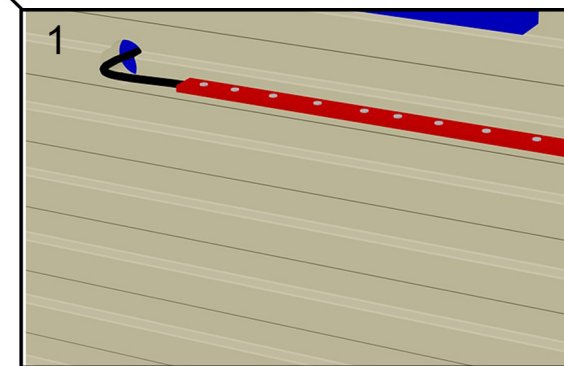
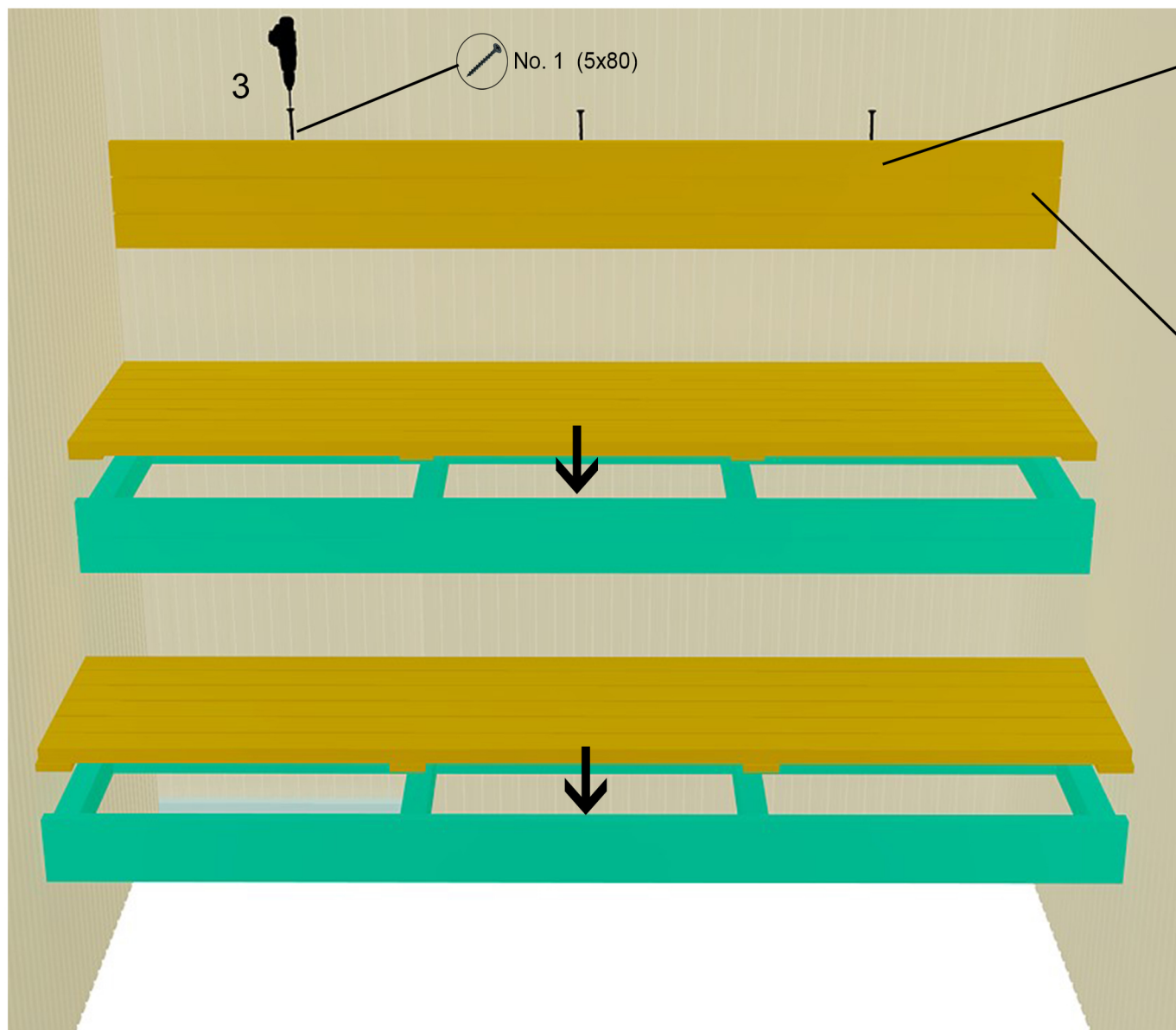

- 1. Push LED-strip cable to ceiling for connection
- 4. Fix LED-strip on top of backrest with glue (covering screws)

19. Interior II

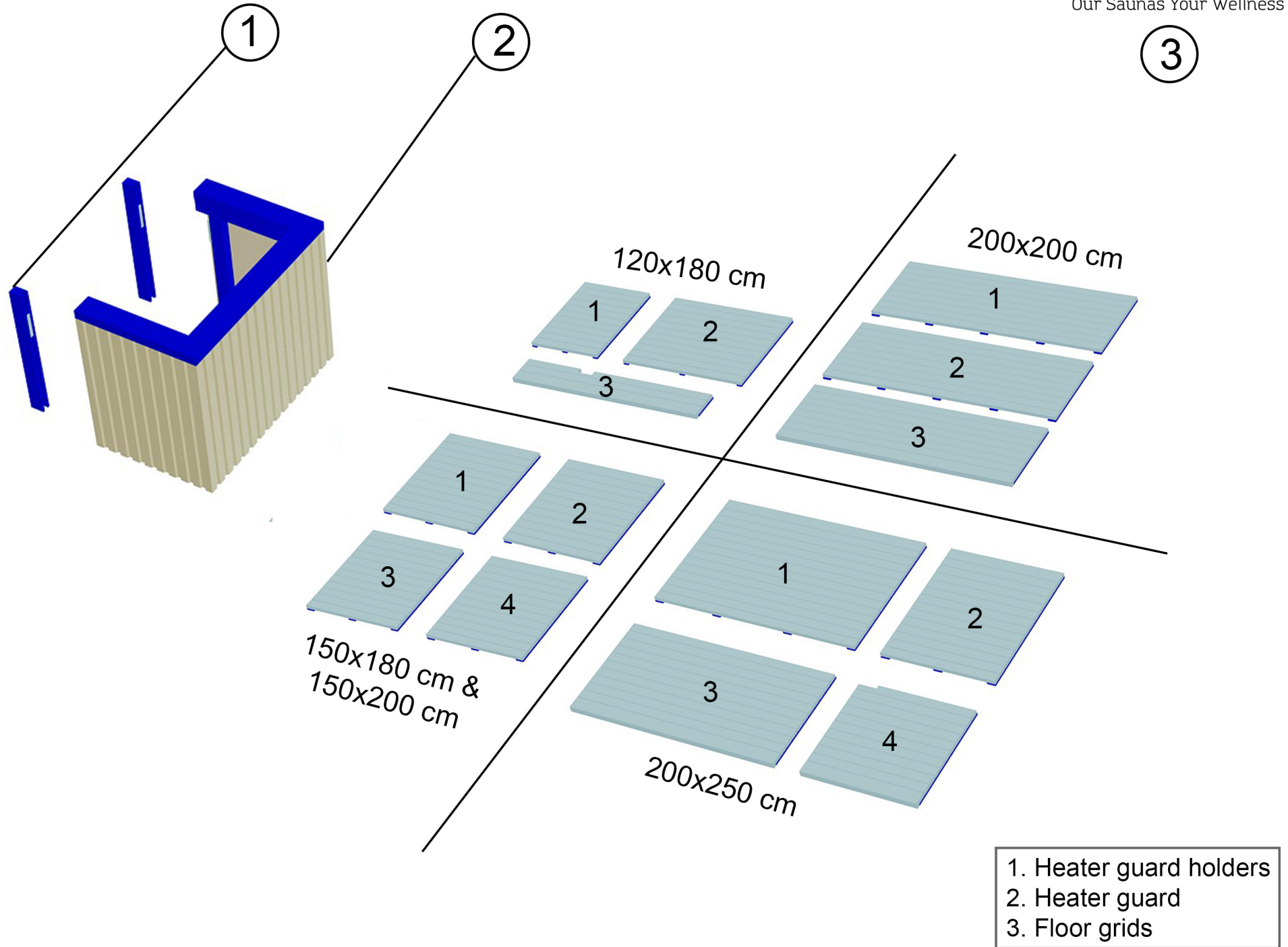

20. Heater guard

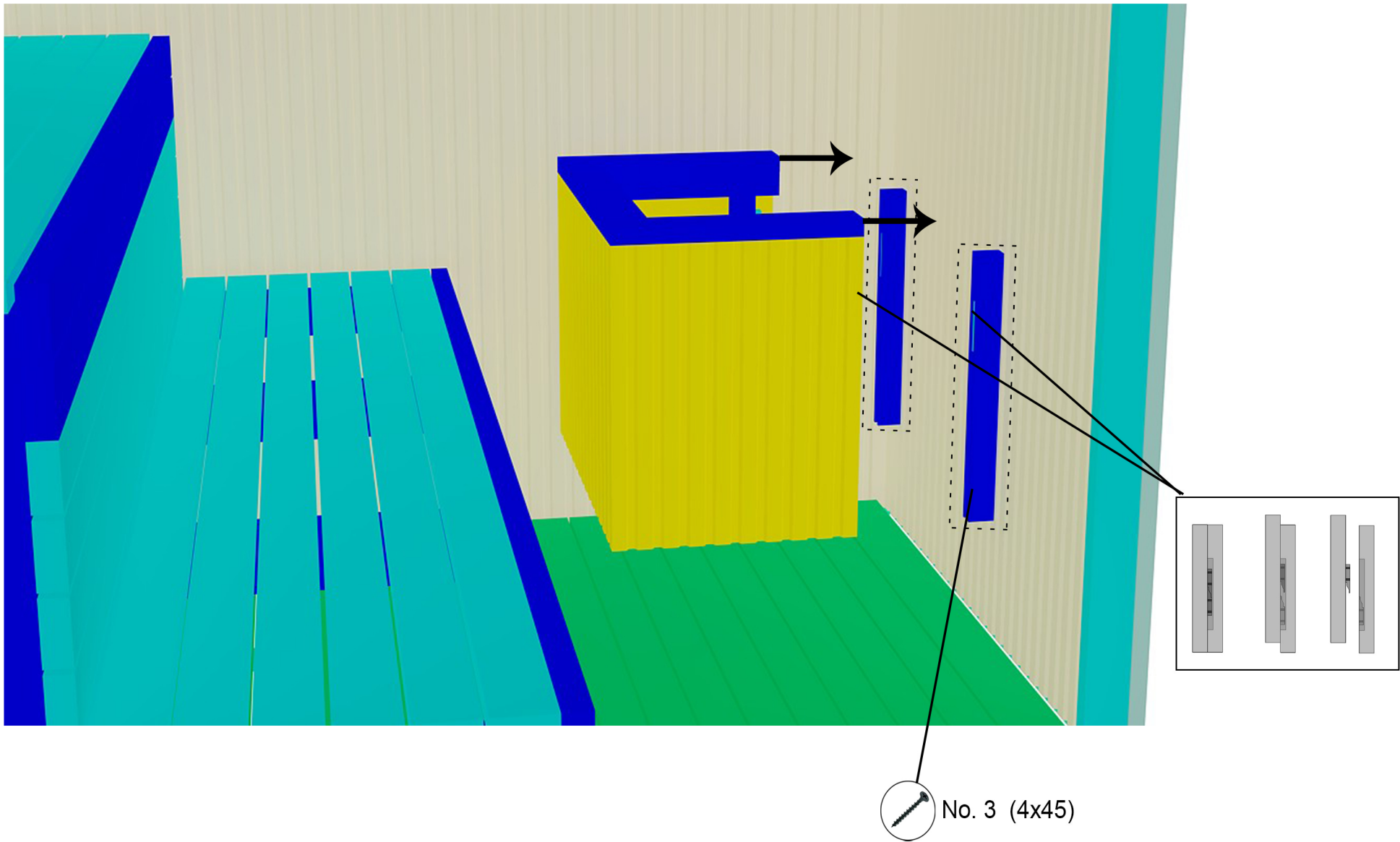

21. Door frames

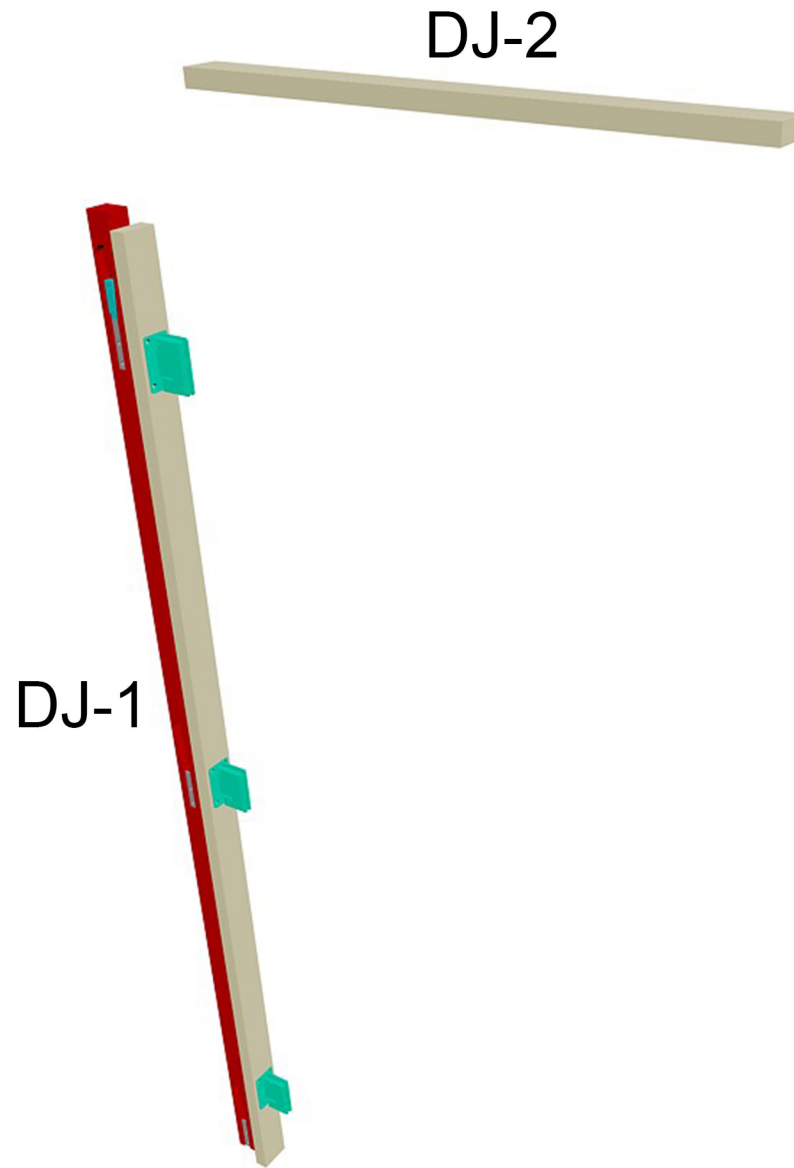

22. Fixing door frames

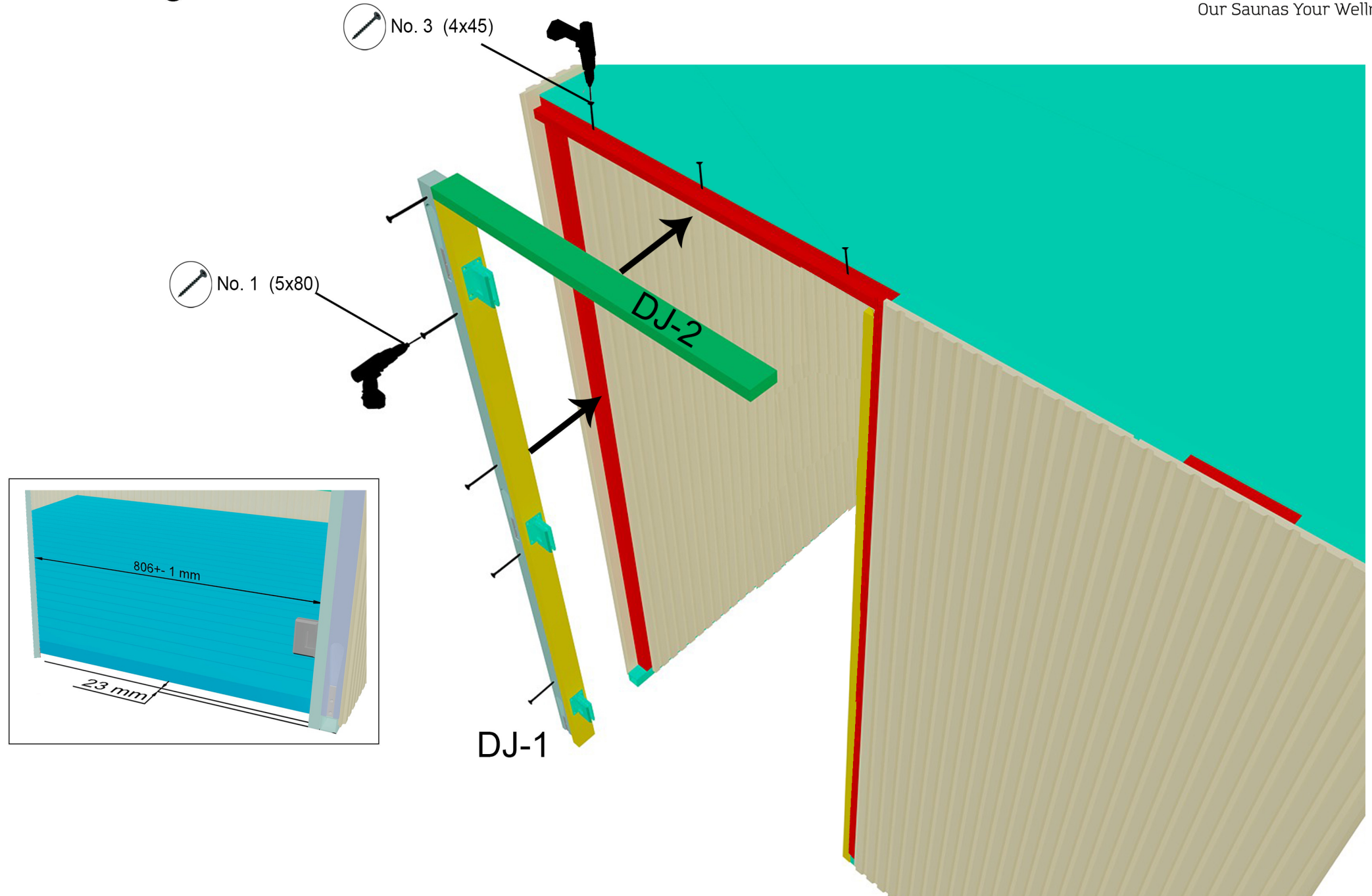

23. Front frame

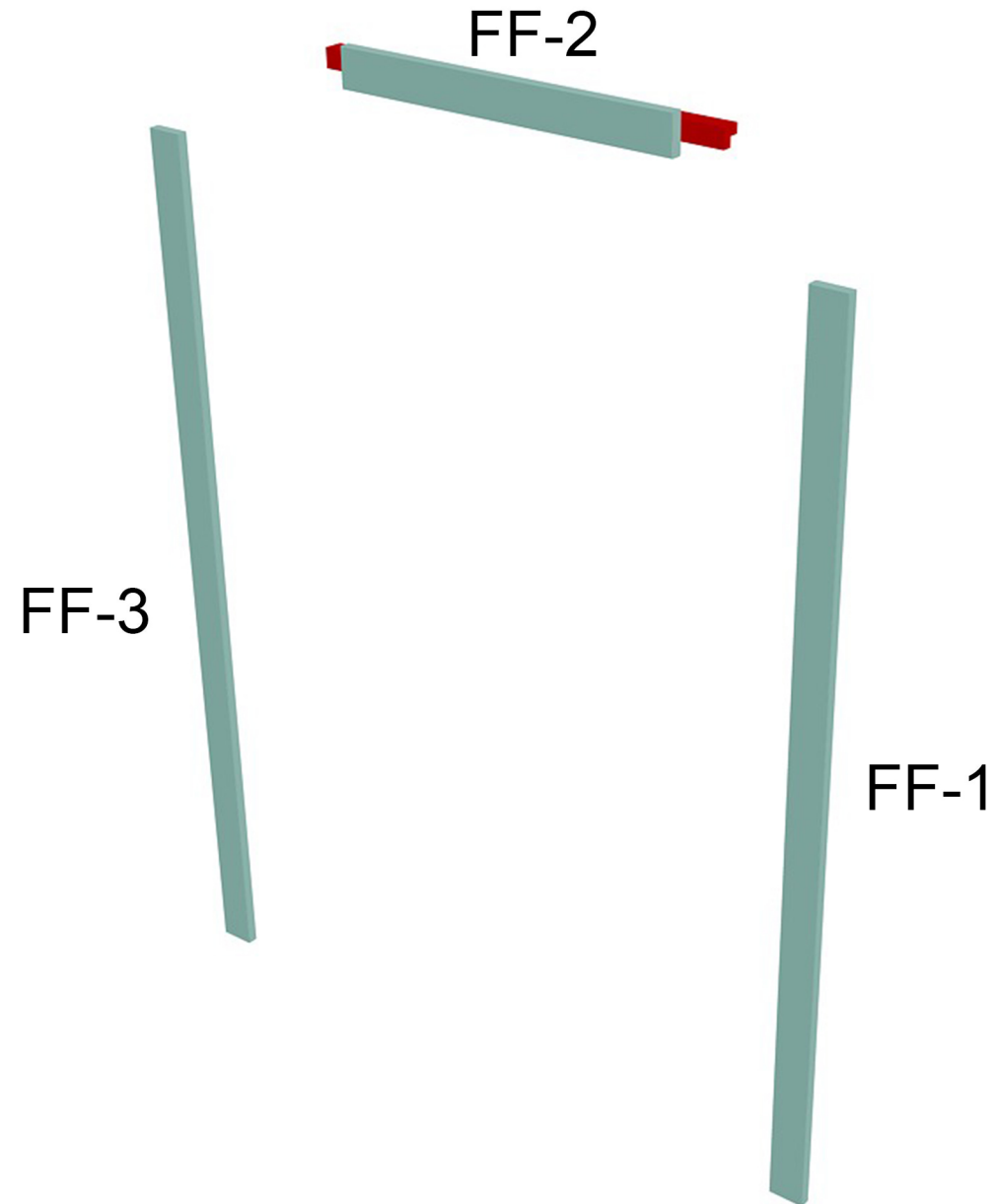

24. Fixing front frame

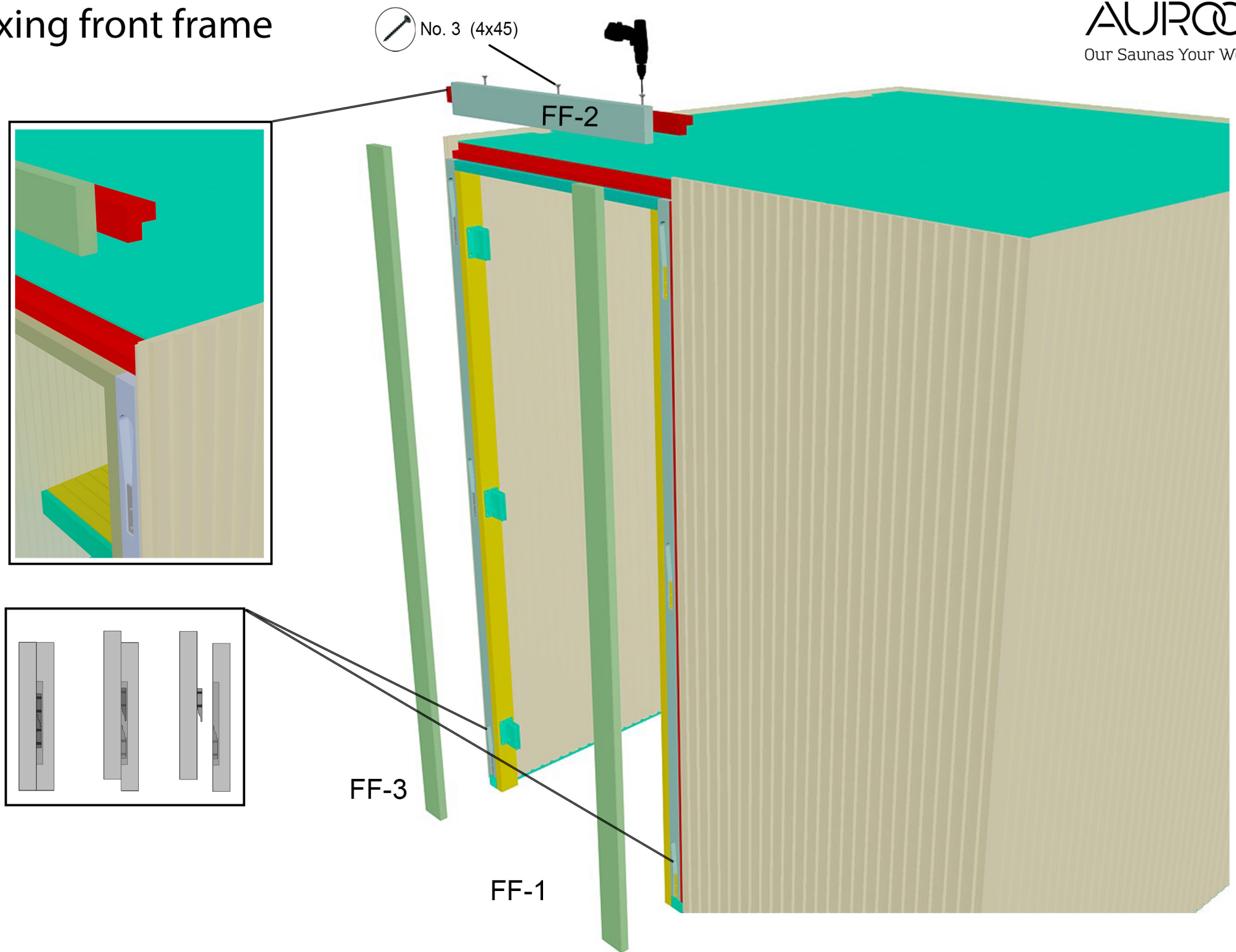

25. Door hinges and handle

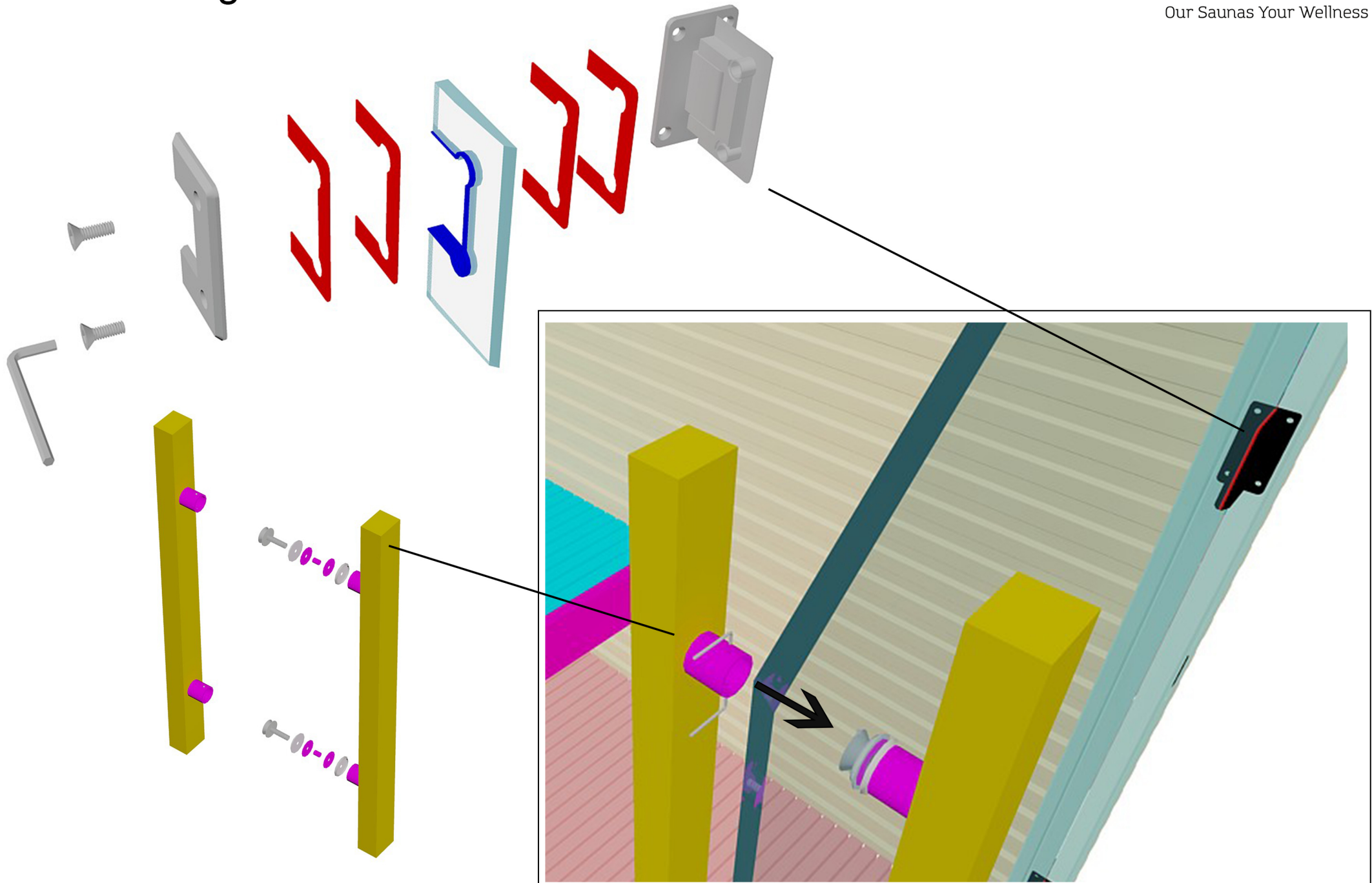

26. Wiring on ceiling

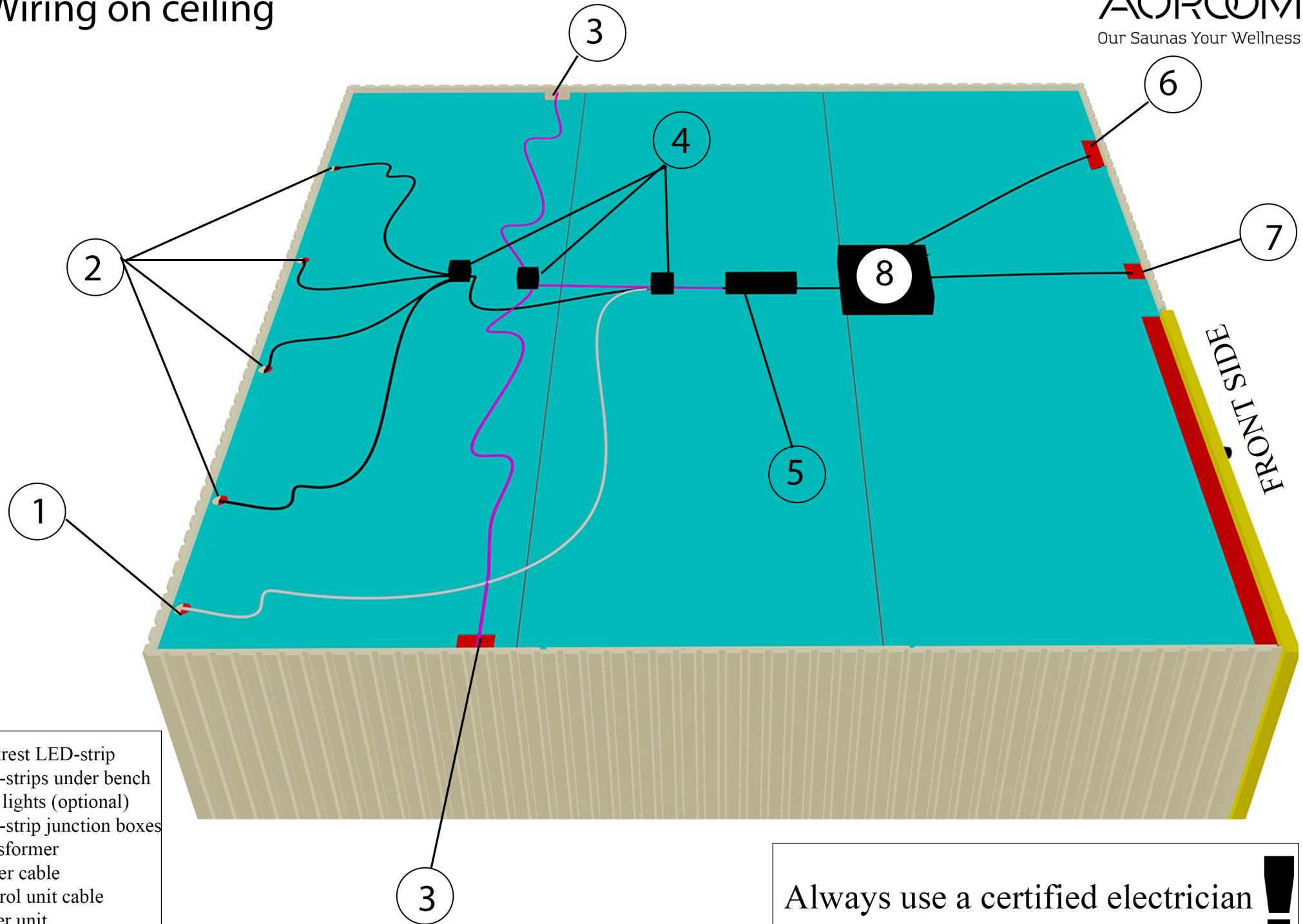

Always use a certified electrician !