

## Irradia

### Installation manual

Dimensions:

100x120 cm

100x150 cm

120x180 cm

150x150 cm

Handedness:

Right

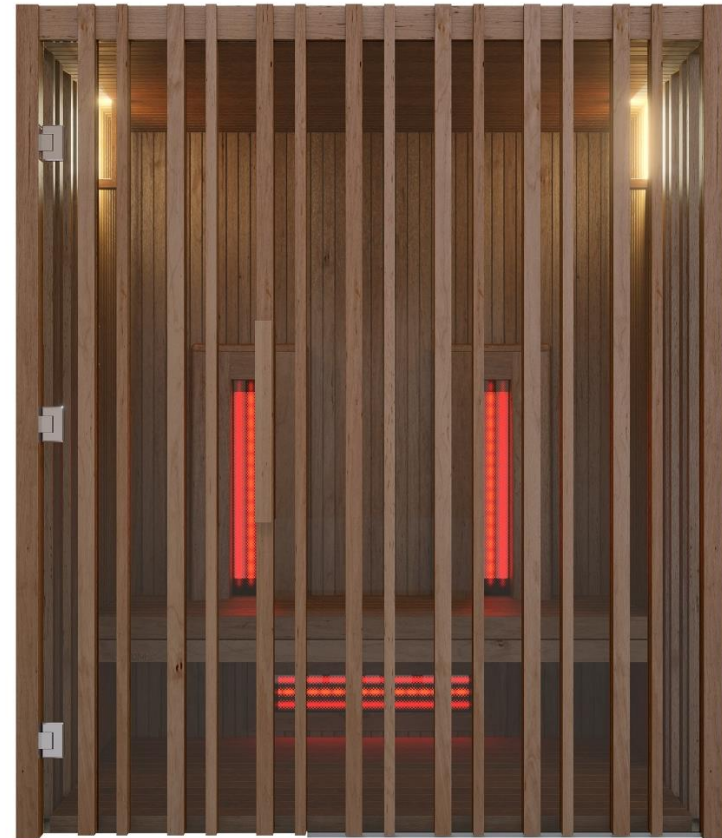

# Leave space for better assembly

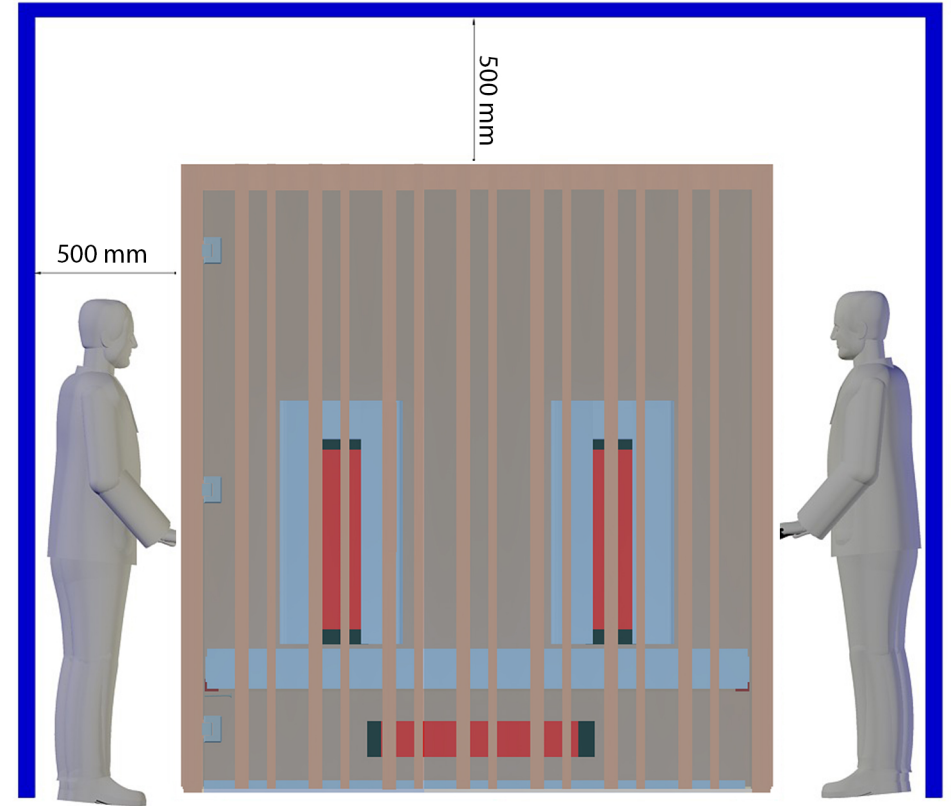
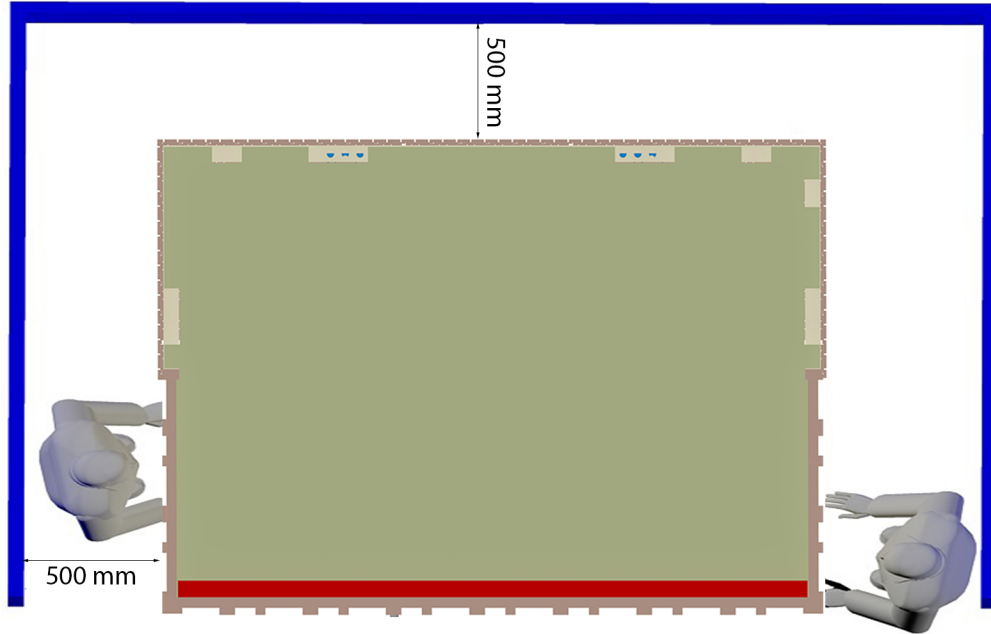

# Tools



# 1. Base frame

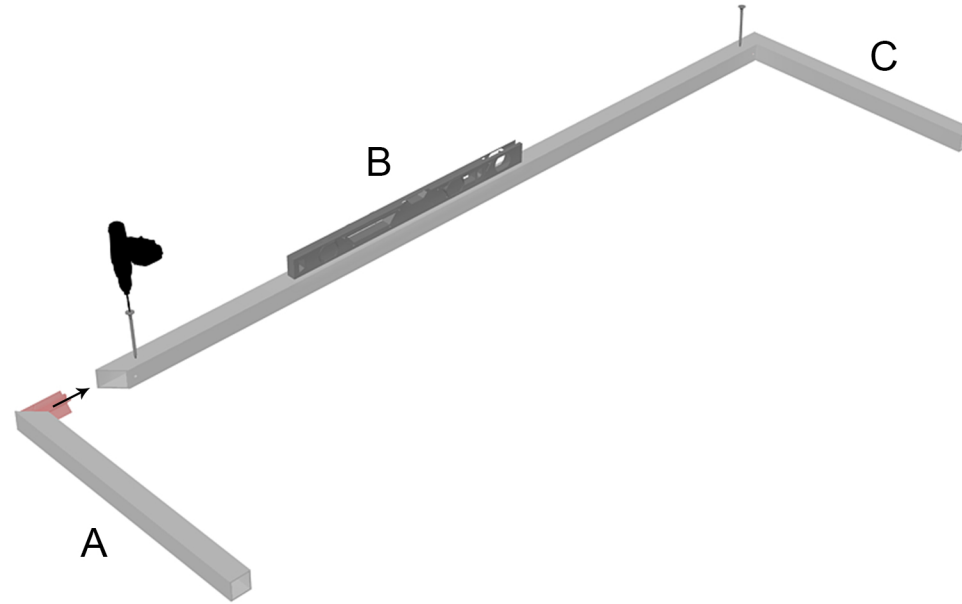

Aluminium

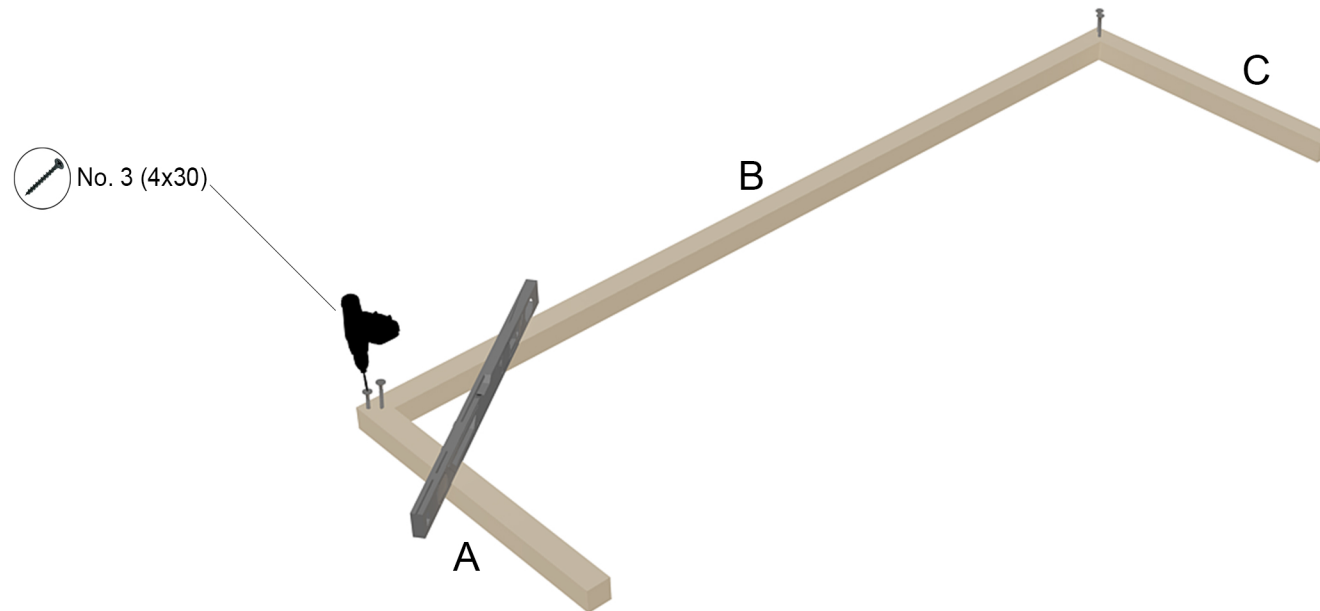

Wood



## 2. Walls

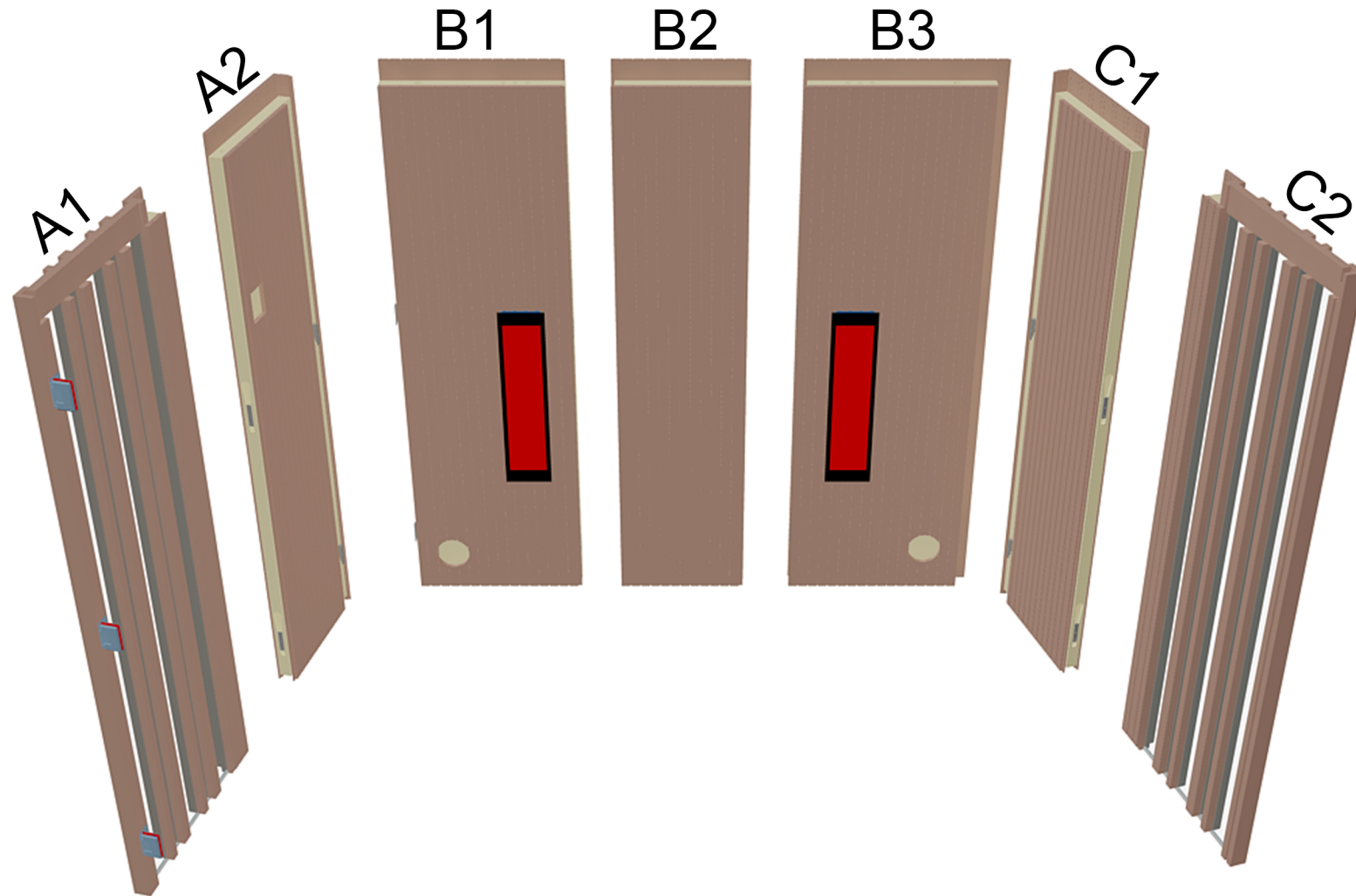

# 3. Multiclip closing system

1.

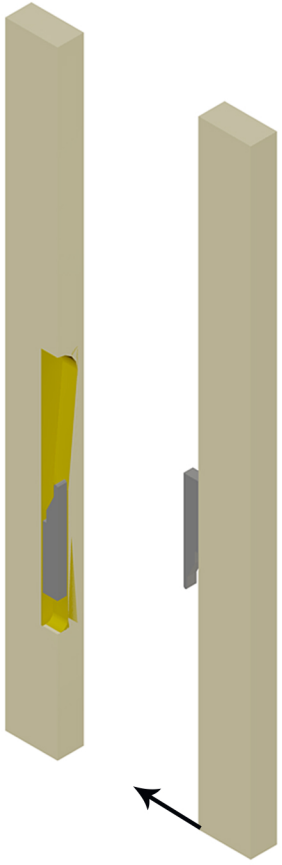

2.

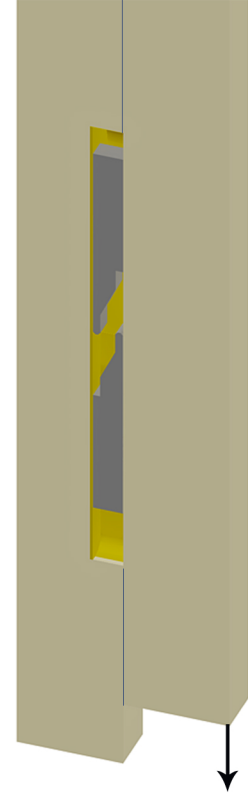

3.

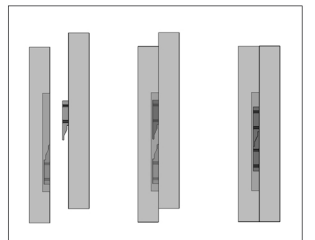
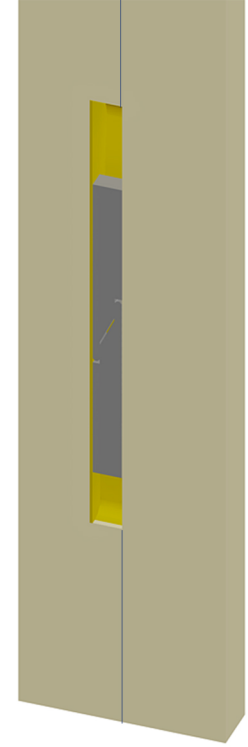

# 4. Fixing A & B walls

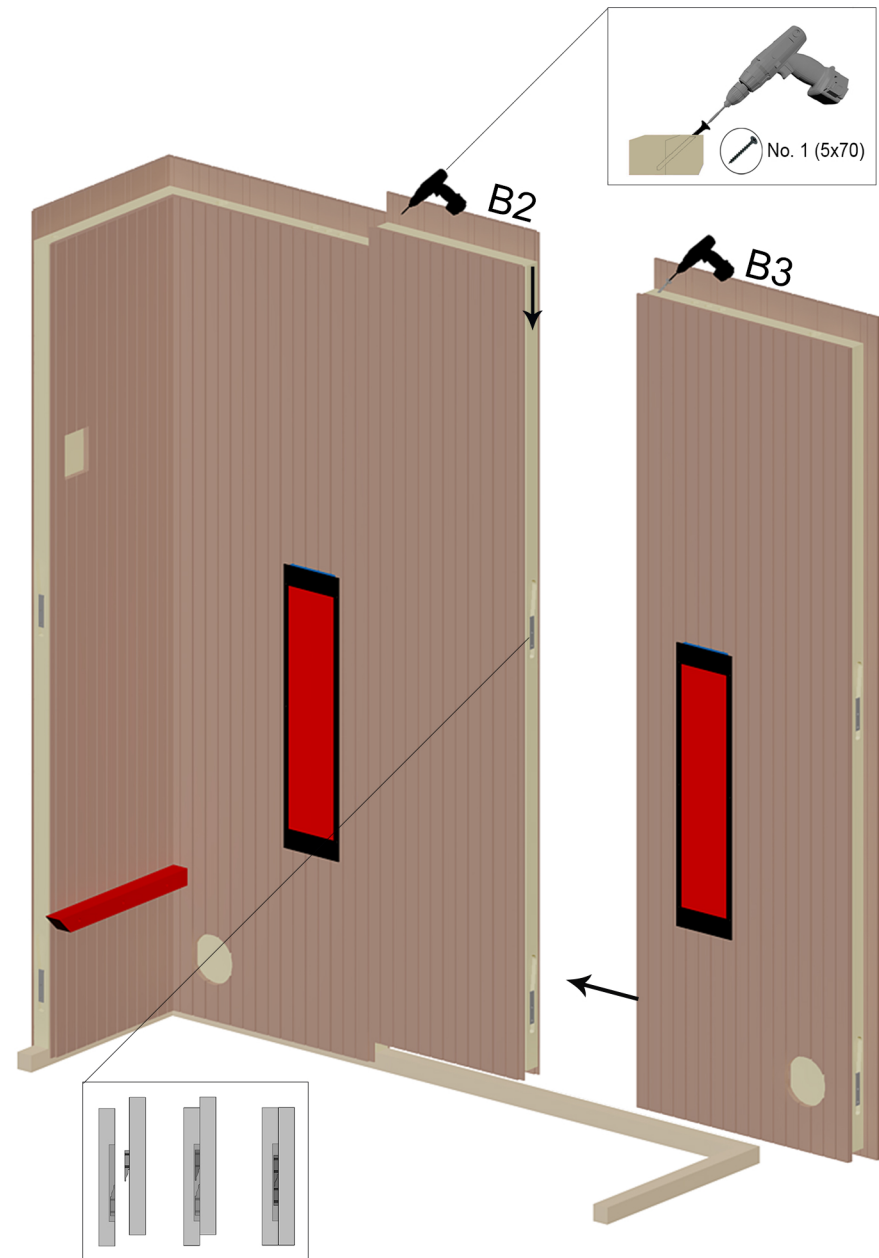
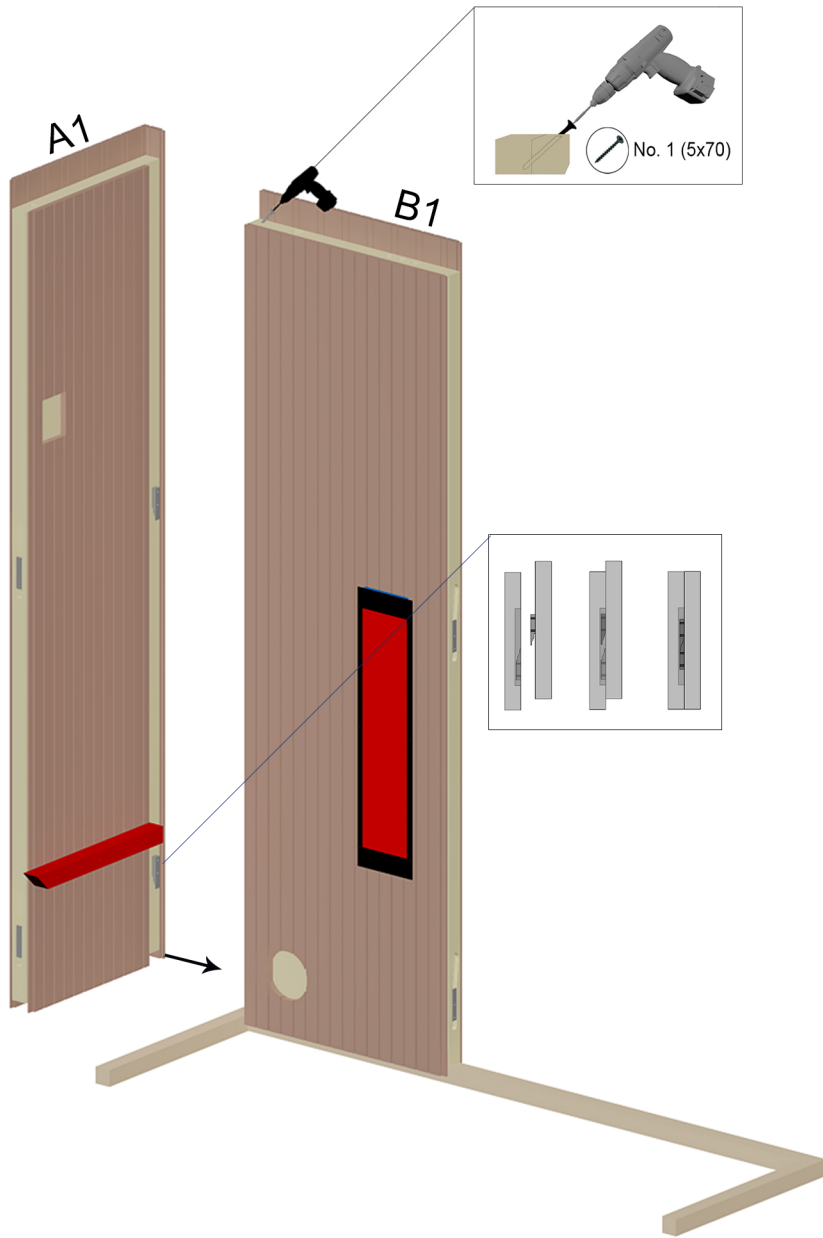

# 5. Fixing C & A walls

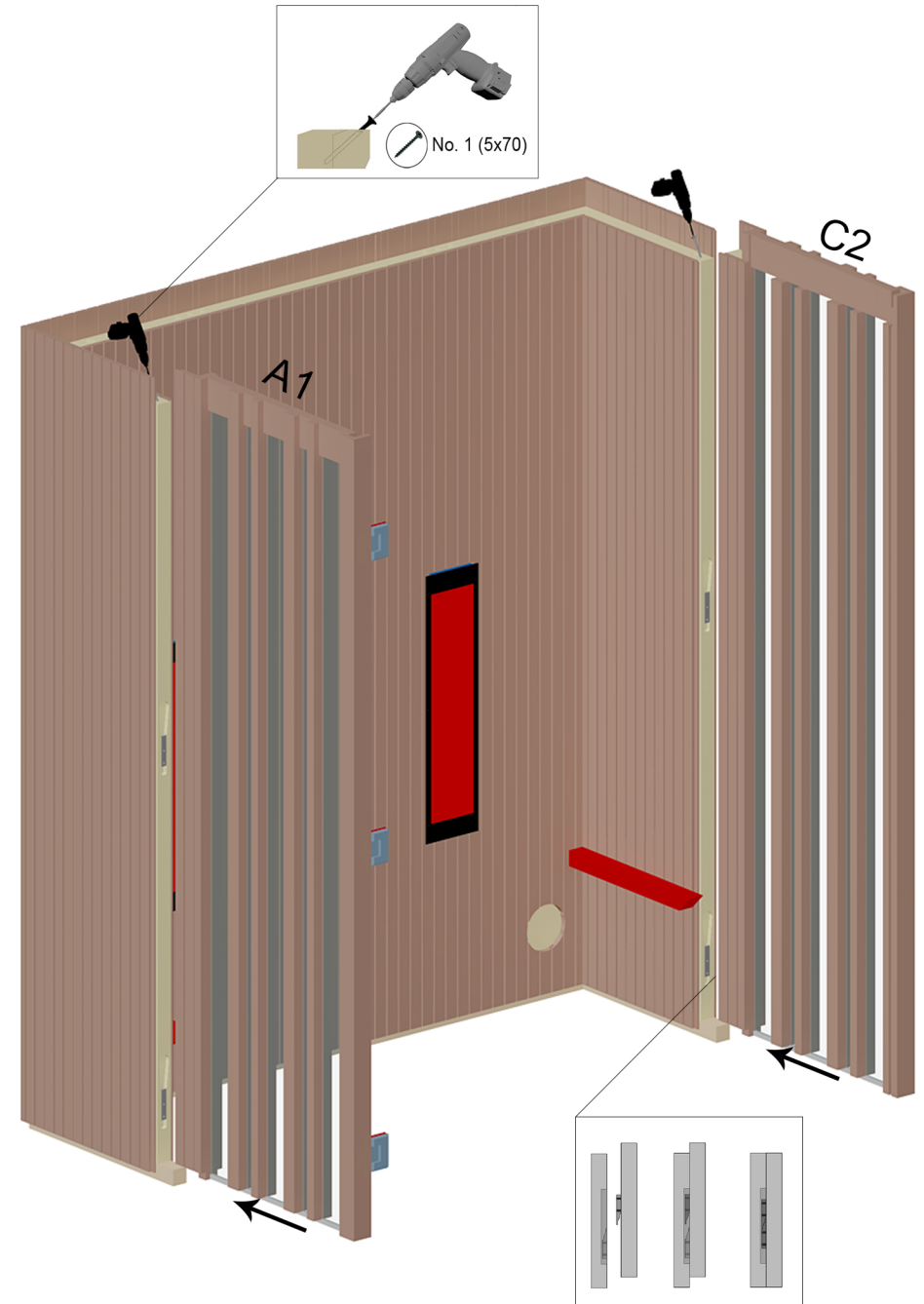
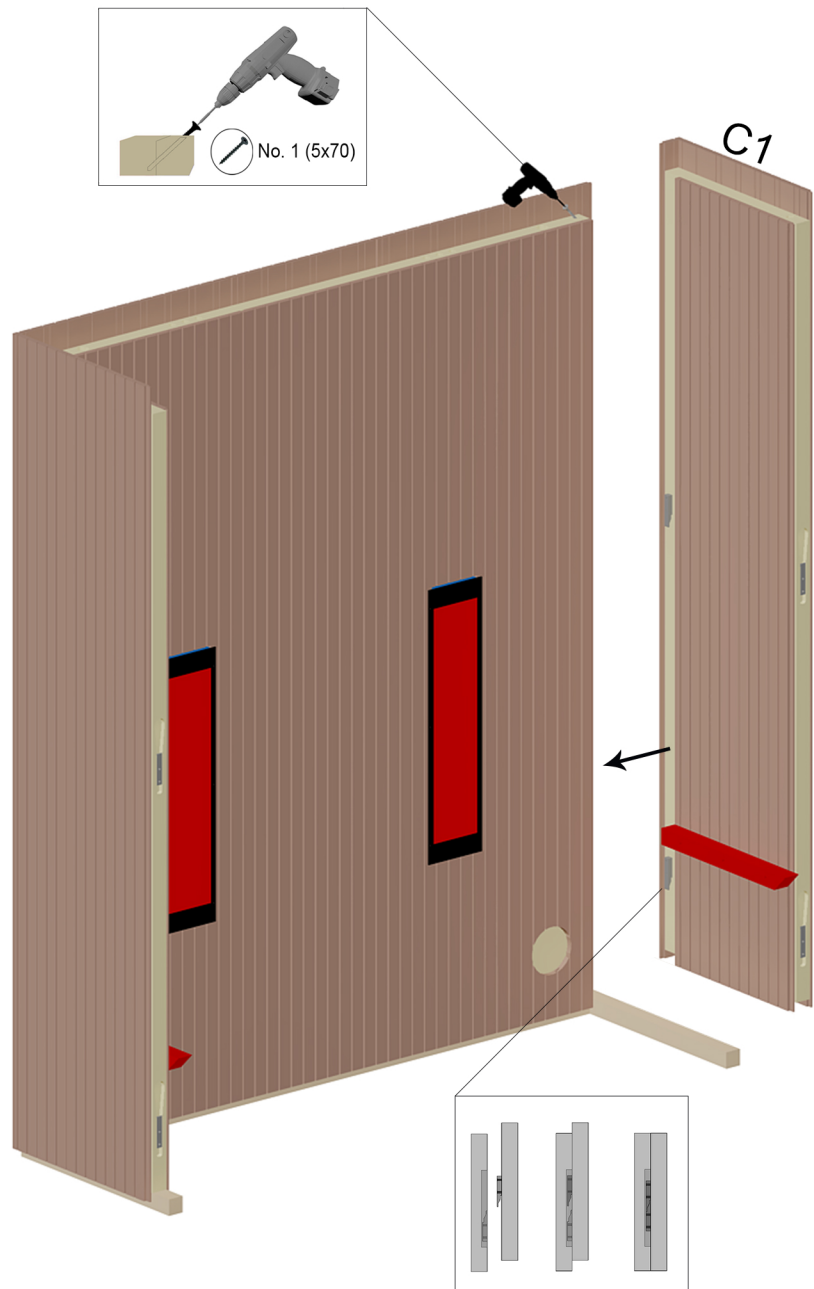

# 6. Fixing ceilings

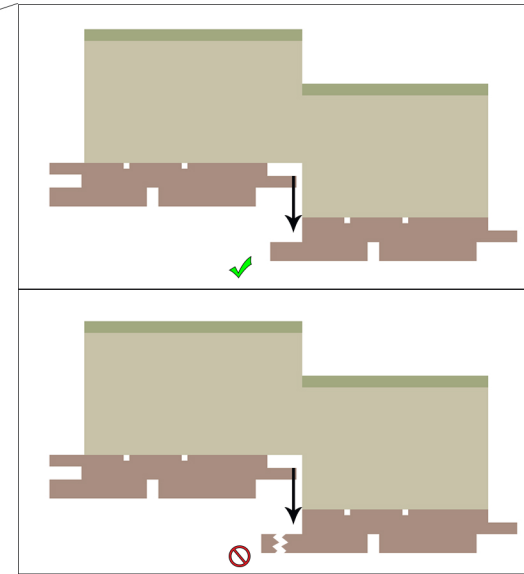
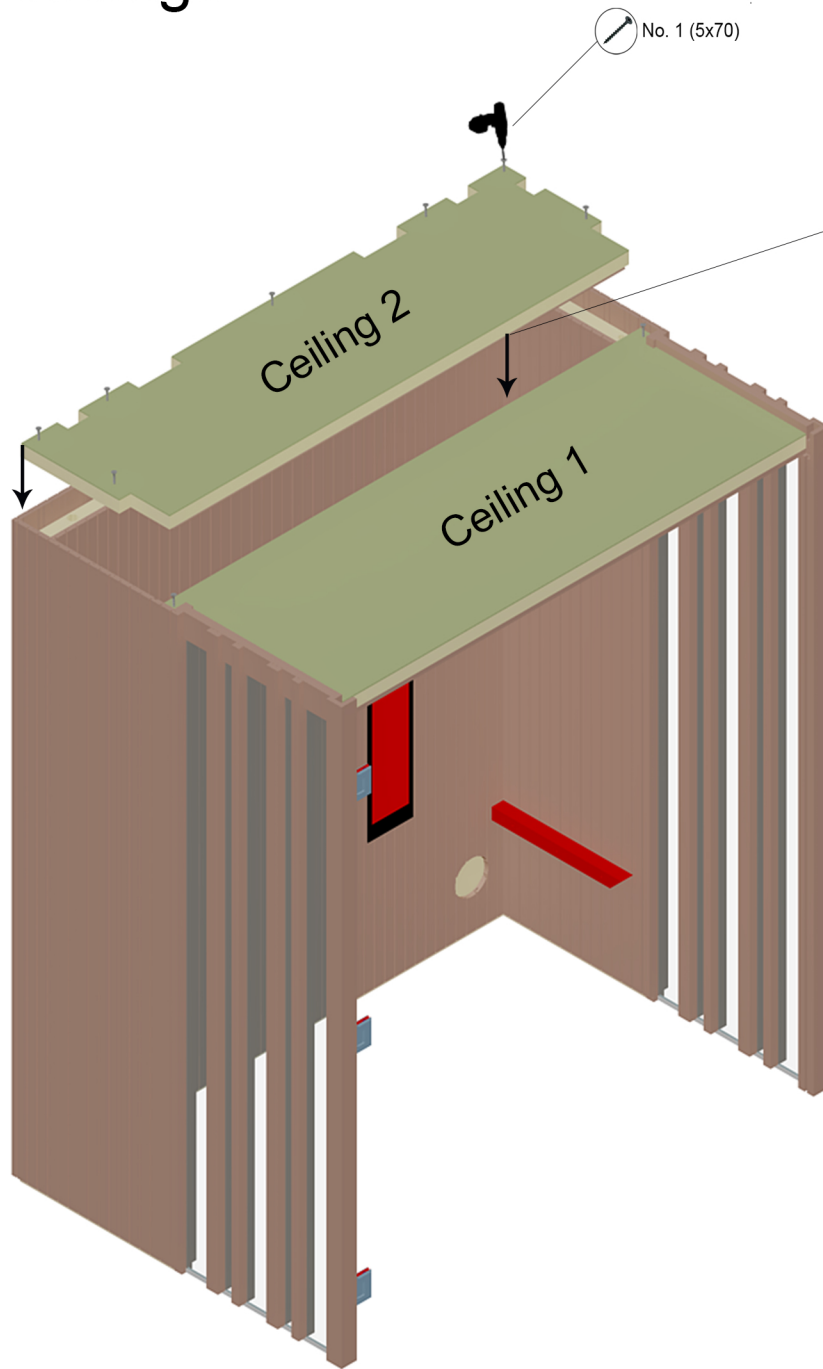

# 7. Fixing glass wall

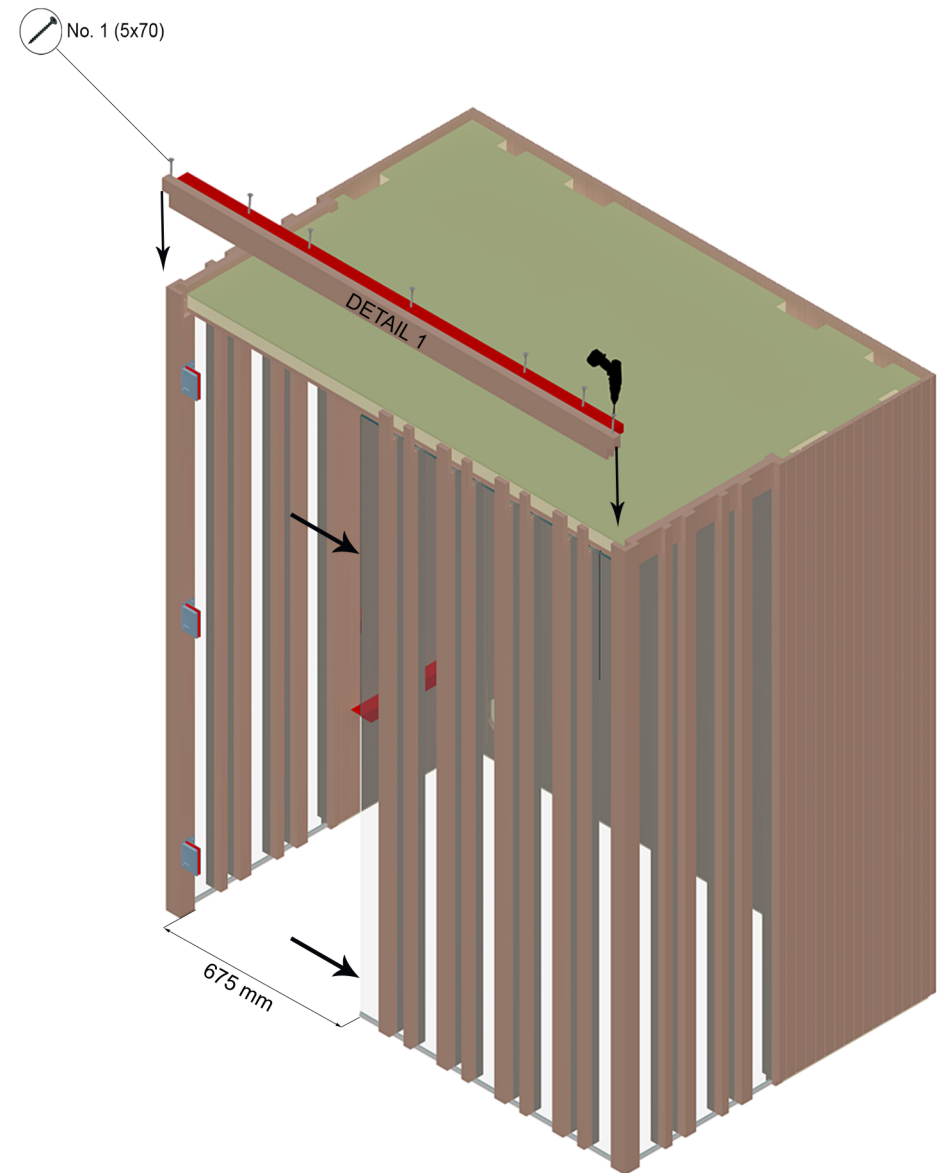
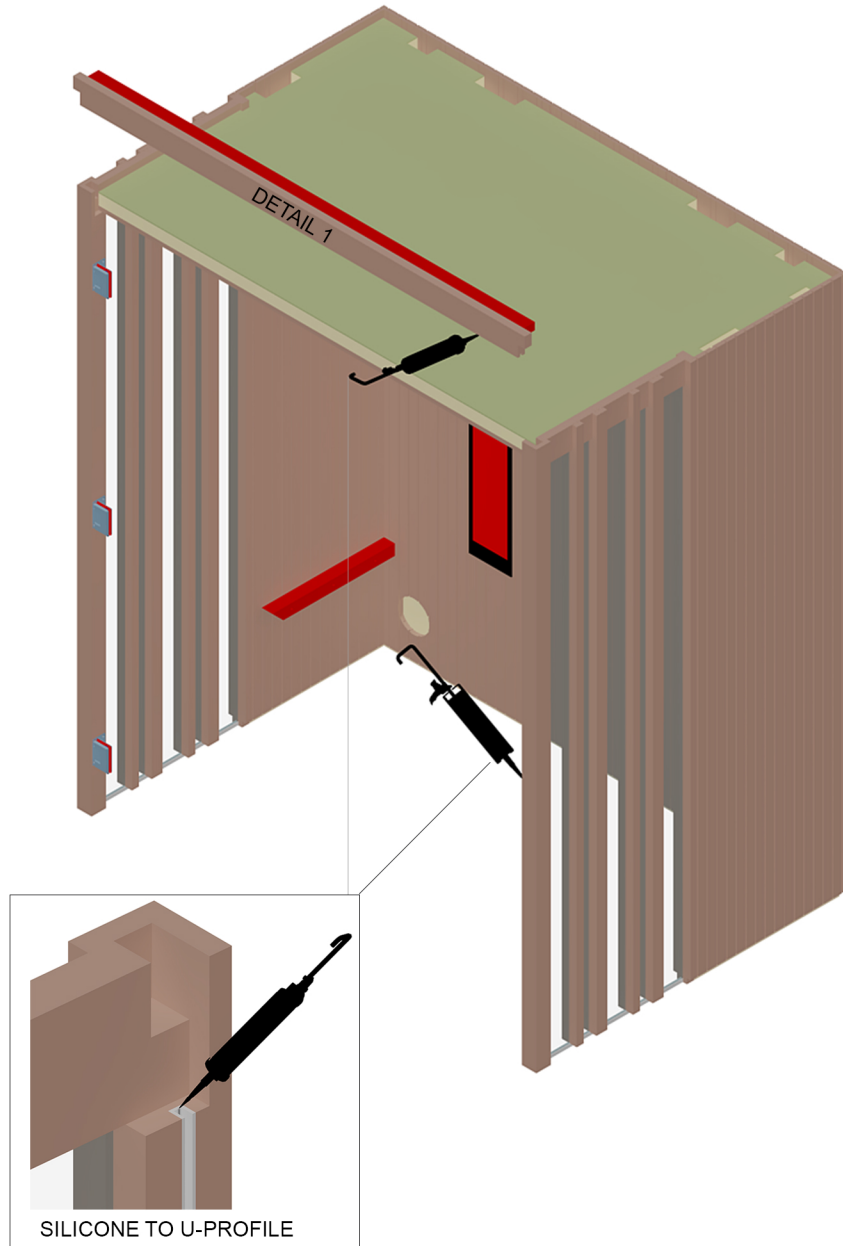

## 8. Interior

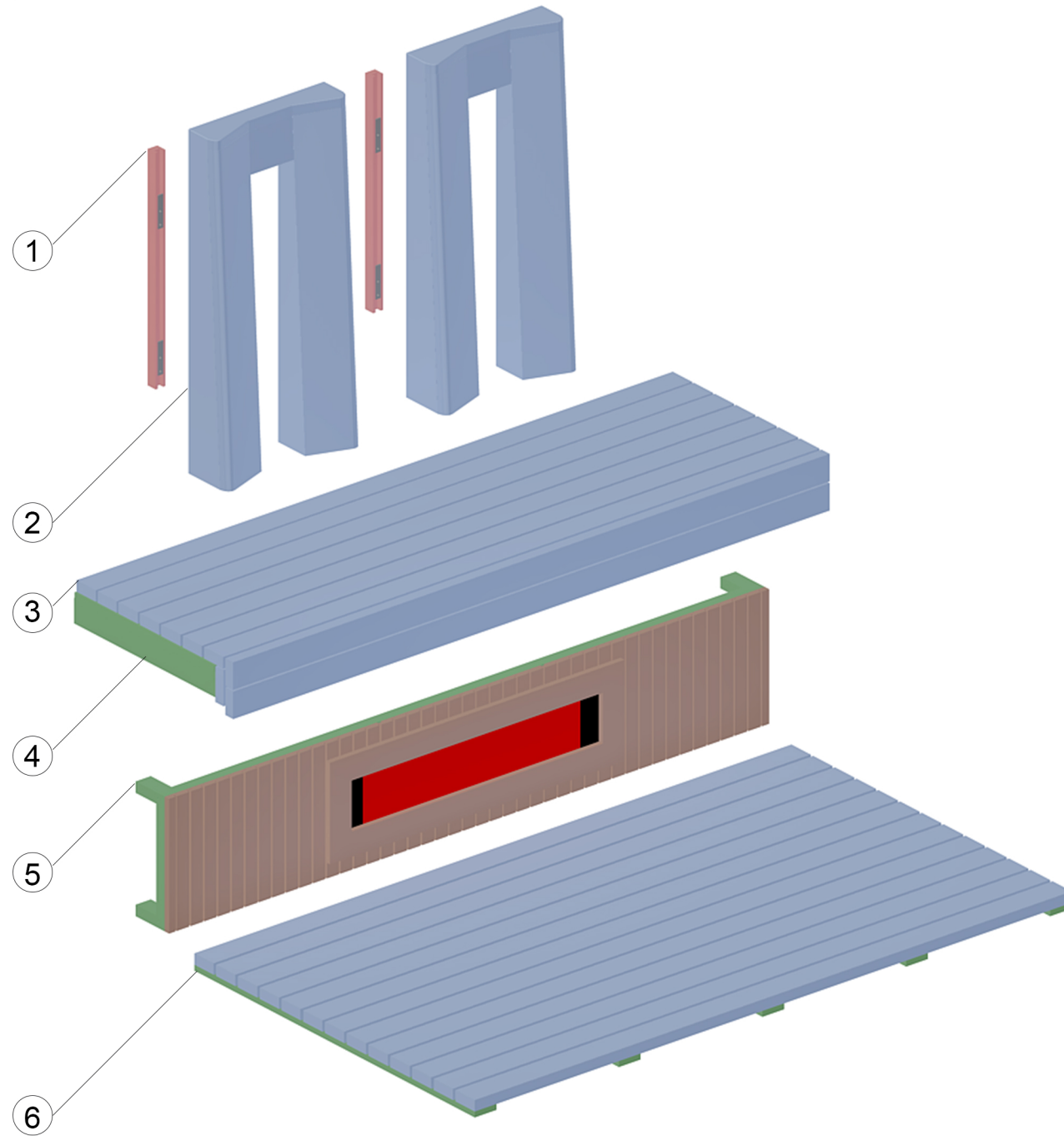

1. Backrest holders (4 pcs)
2. Backrest (2 pcs)
3. Bench grid
4. Bench frame
5. Benchskirt
6. Floor grids

# 9. Fixing bench skirt

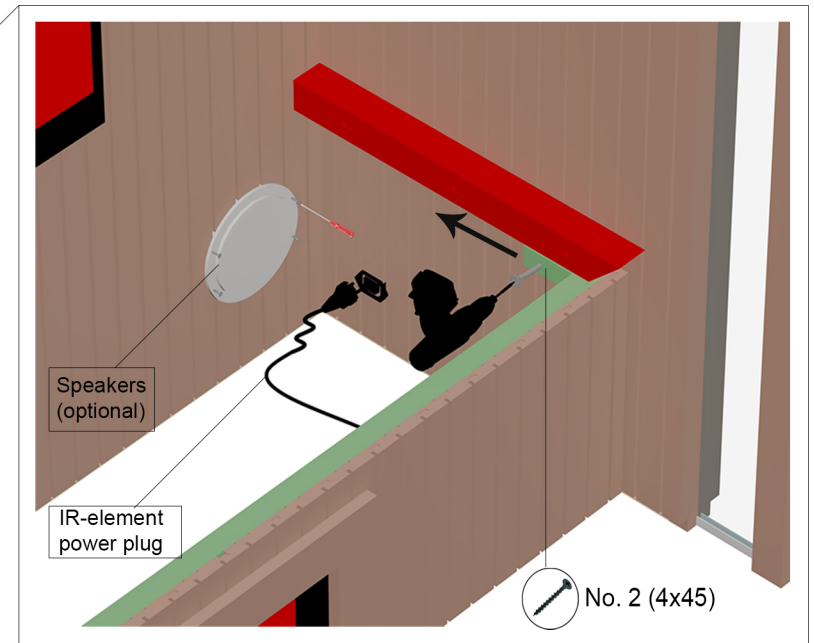
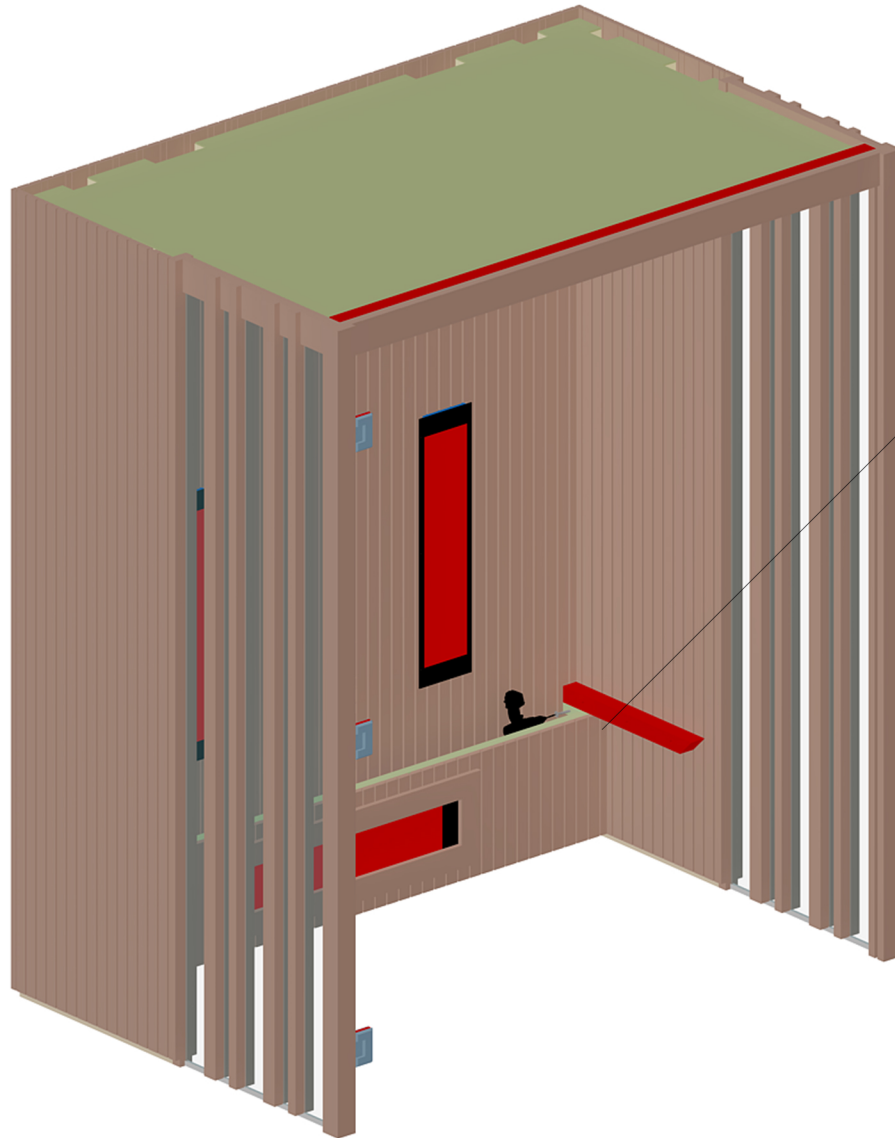



# 10. Fixing bench frame & bench grid

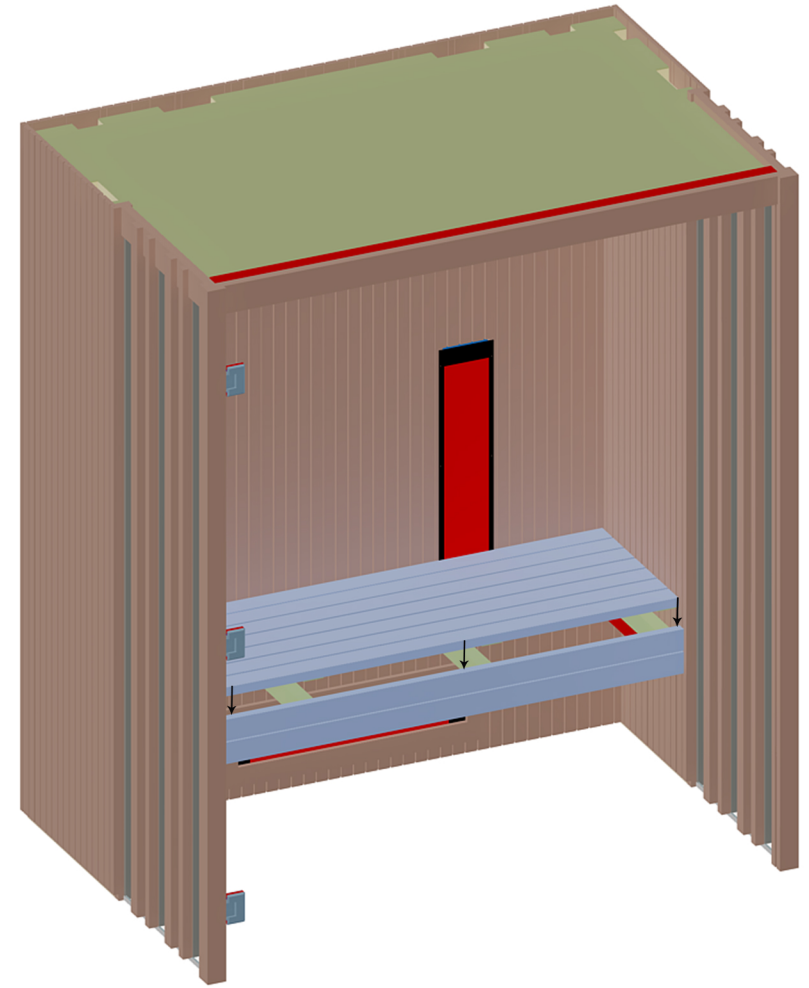
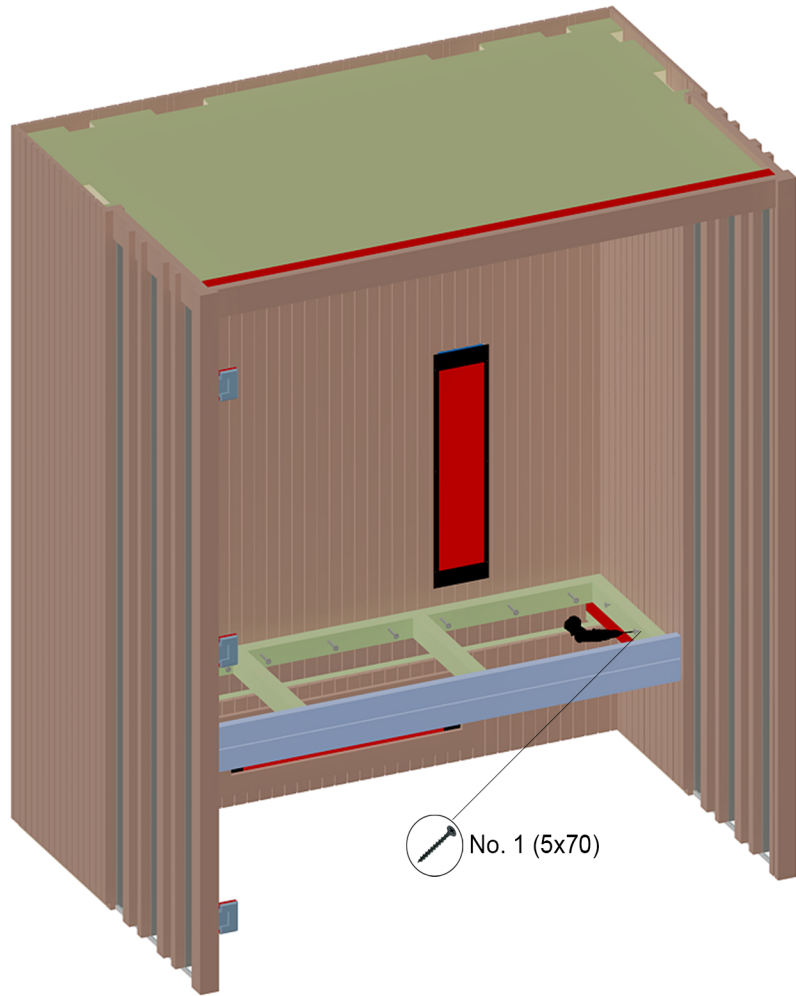

# 11. Fixing backrest

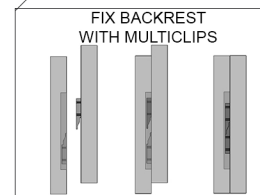
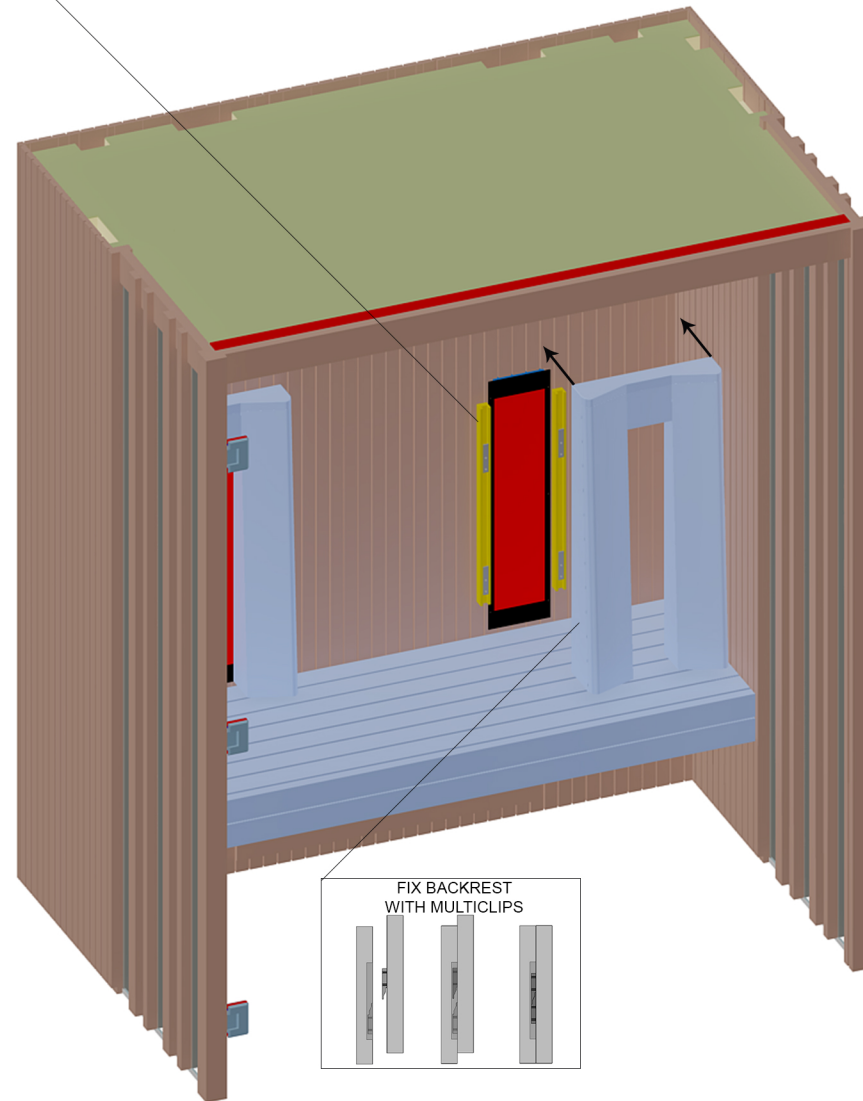
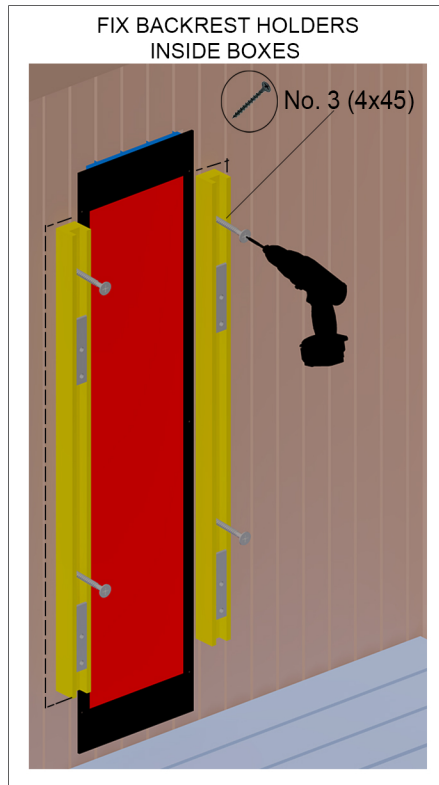

# 12. Floor grids

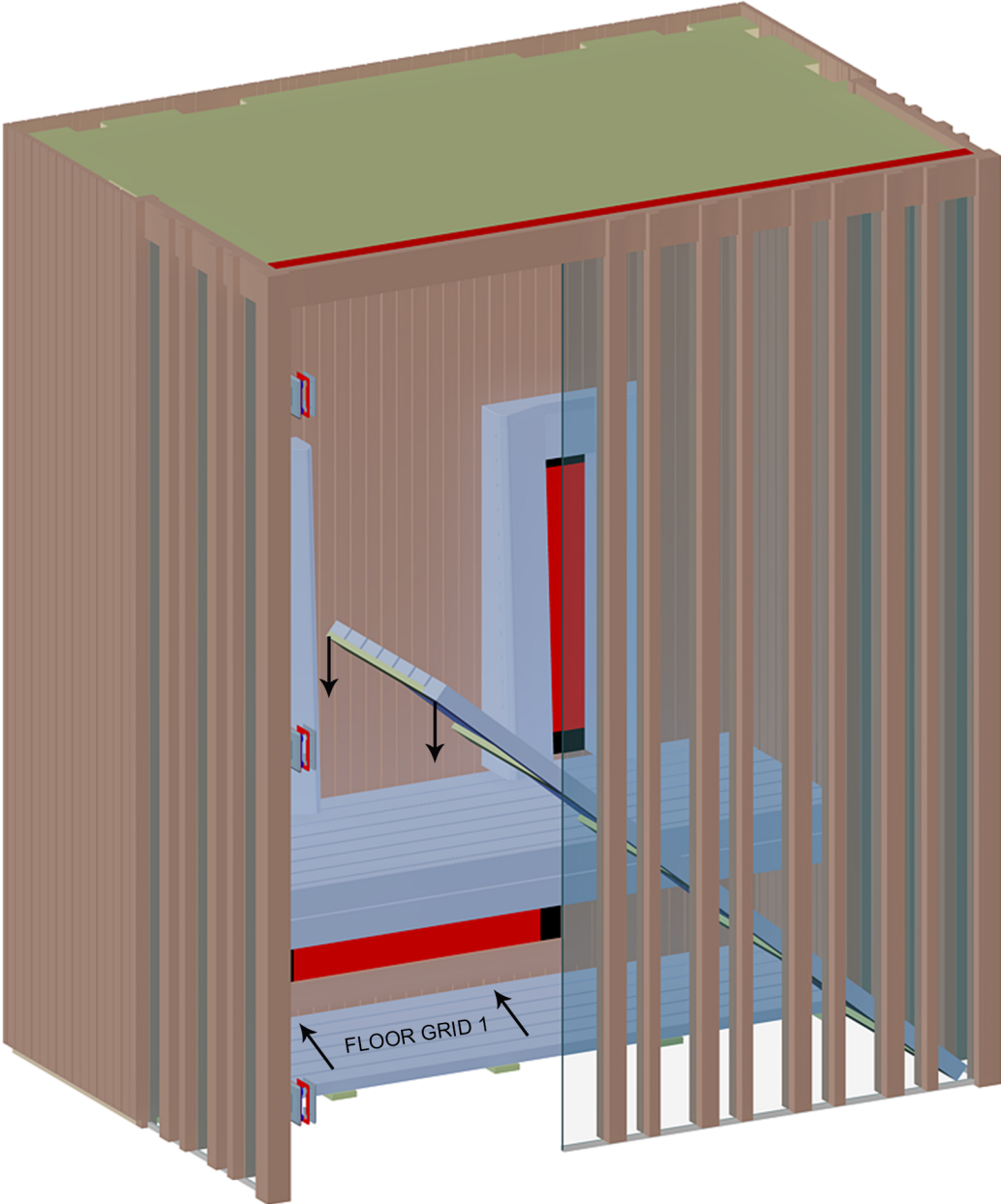

# 13. Fixing door & handle

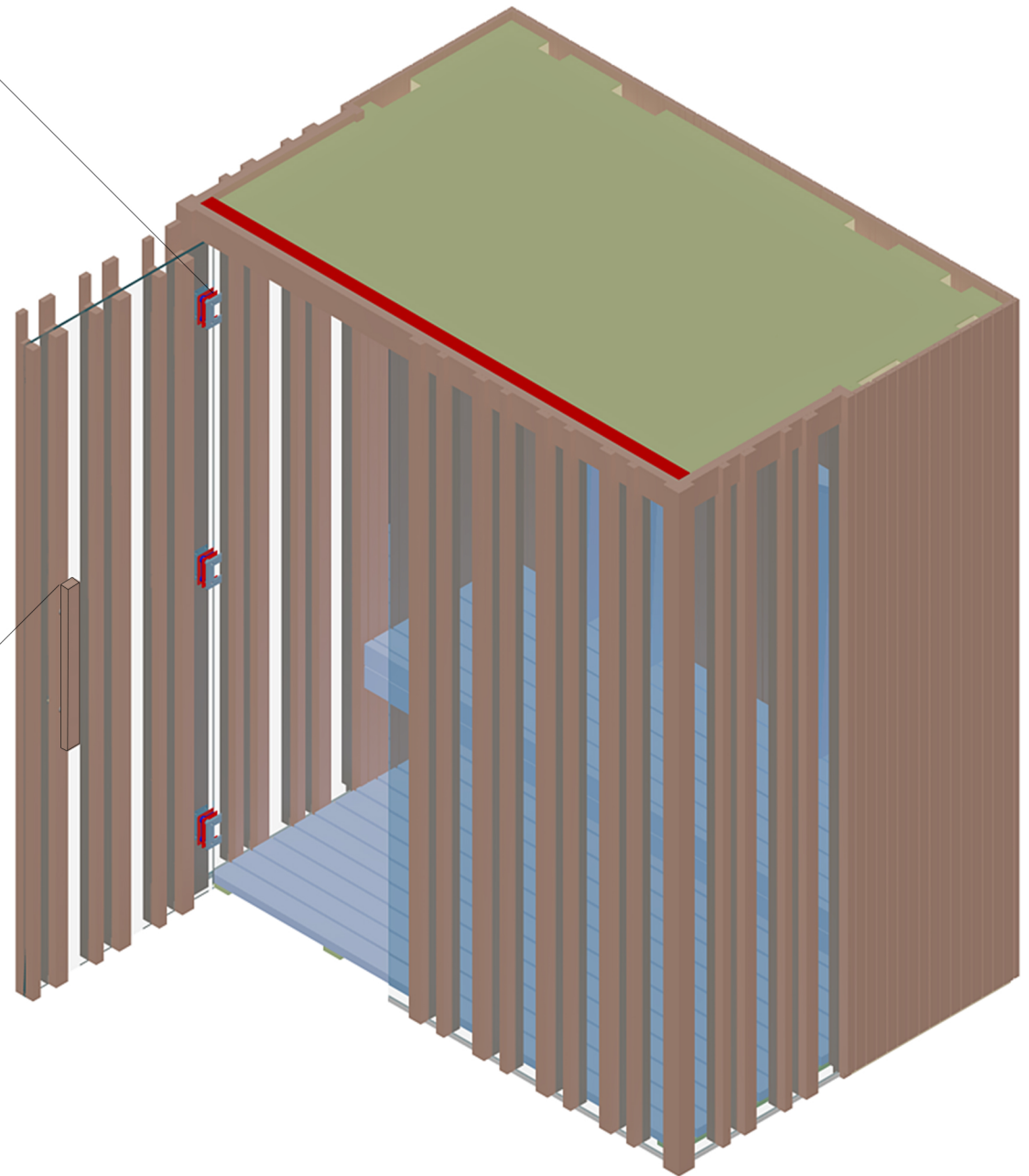
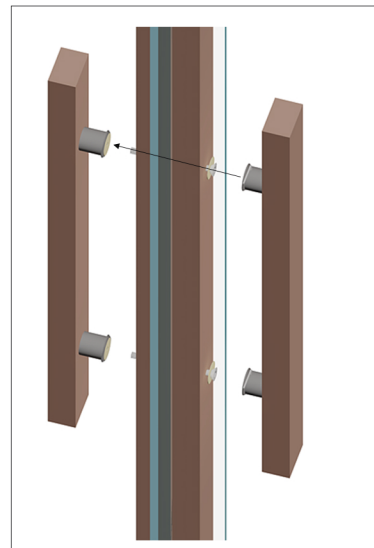
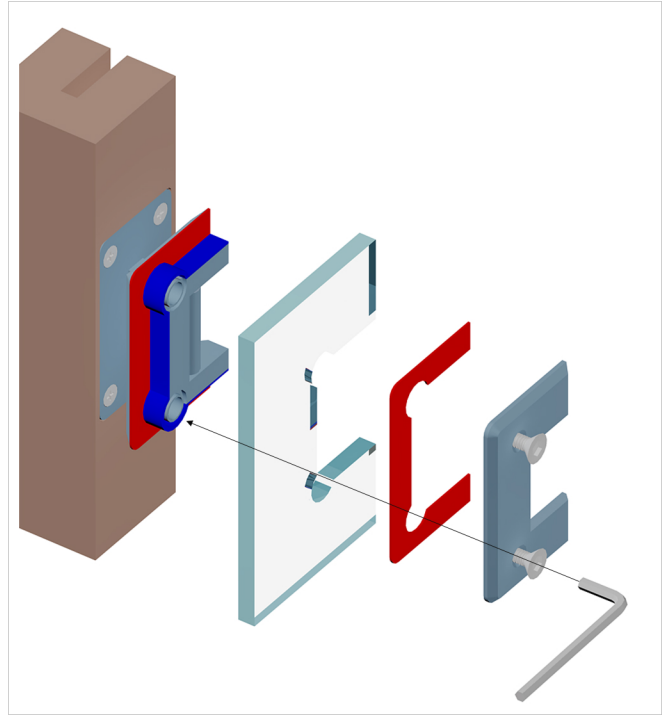

# 14. Electric scheme

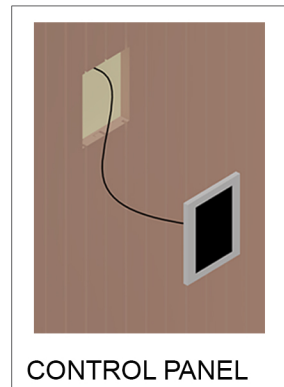
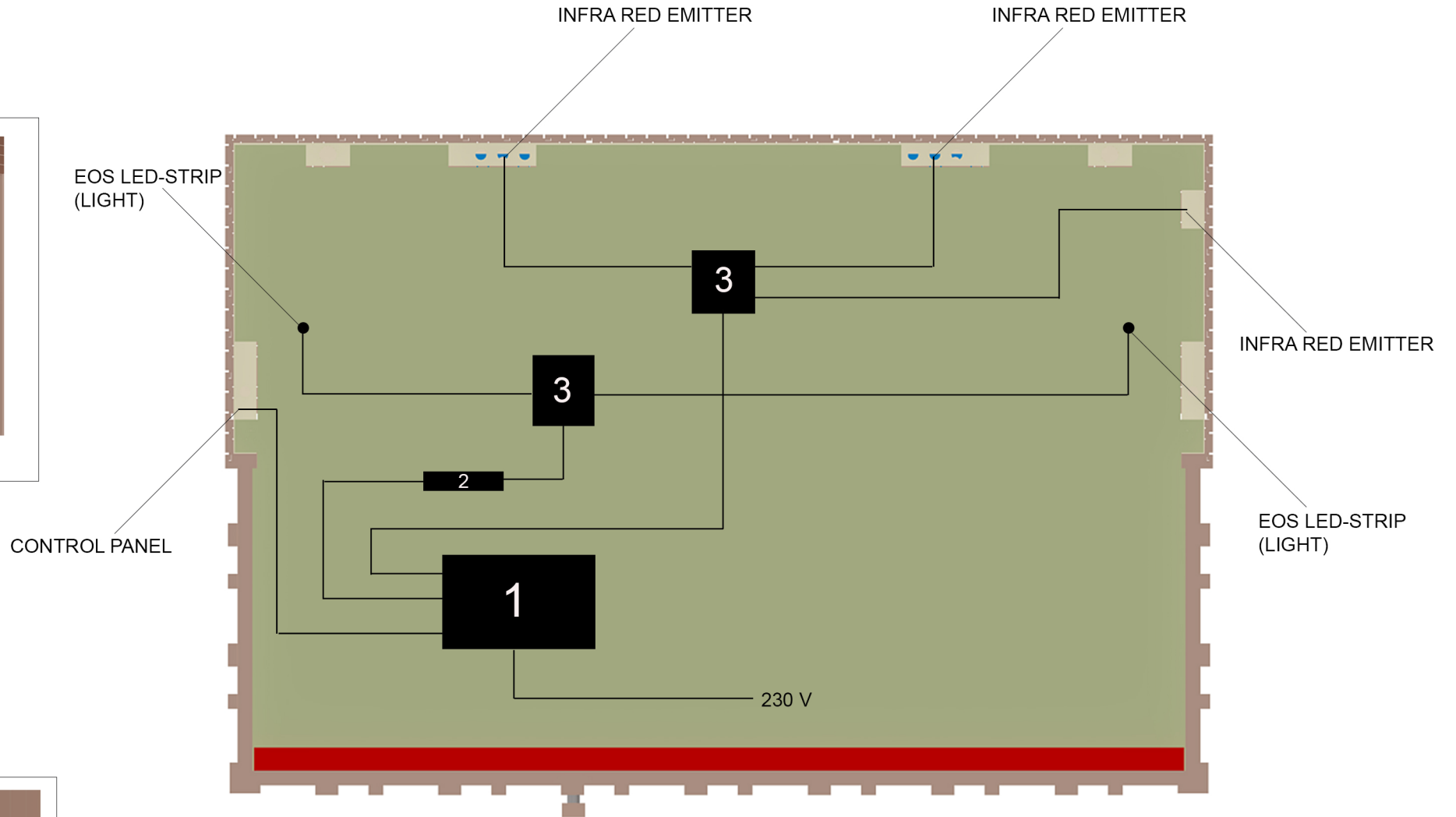
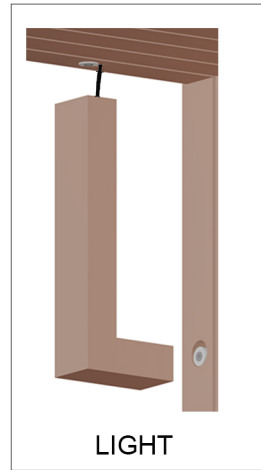

- 1. Power unit
- 2. Transformer
- 3. Junction box

Always use certified electrician !